

# Instructions and Maintenance Original Manual

QJY3.0-E  
Two post lift



**CONTENTS**

1 Safety ..... 3

1.1 Introduction ..... 3

1.2 Symbols ..... 3

1.3 Intended Use ..... 3

1.4 Safety Instructions for Commissioning ..... 3

1.5 Safety Instructions for Operation ..... 4

1.6 Safety Instructions for Servicing ..... 4

1.7 Safety Features ..... 4

2 Production information ..... 5

2.1 Specifications ..... 5

2.2 Safety warnings ..... 6

3. Packing, transport and storage ..... 7

3.1 Packing ..... 7

3.2 Lifting and handling ..... 7

3.3 Storage and stacking of packages ..... 7

3.4 Delivery and check of packages ..... 8

4 Installation ..... 8

4.1 Space required ..... 8

4.2 Installation steps ..... 9

5 Operation ..... 10

5.1 Controls ..... 10

5.2 Operation ..... 11

6 Maintenance ..... 13

6.1 Maintenance schedule ..... 13

6.2 Annual inspection ..... 14

6.3 Maintenance by the operator ..... 14

6.4 Cleaning ..... 15

7 Troubleshooting ..... 15

8 Disposal ..... 15

9 Attached drawings ..... 16

10.1 Electrical drawing ..... 16

10.2 Hydraulic drawings ..... 16

10.3 Explosive view ..... 16

## 1 Safety

### 1.1 Introduction

Thoroughly read this manual before operating the lift and comply with the instructions. Always display the manual in a conspicuous location.

Personal injury and property damage incurred due to non-compliance with these safety instructions are not covered by the product liability regulations.

### 1.2 Symbols



Failure to comply with instructions could result in personal injury



Failure to comply with instructions could result in property damage



Important information

### 1.3 Intended Use

The lift is designed for the safe lifting of automotive vehicles and forbidding to park vehicles. Observe the rated load capacity and load distribution of the lift.

QJY3.0-E	Load capacity	Load distribution	
		Front: Rear	Minimum
	3000kg	2:3	3:2

In principle, the lift is designed for both approach directions.

For a long service life, we recommend to use the short support arms for engaging the engine side of the vehicle.

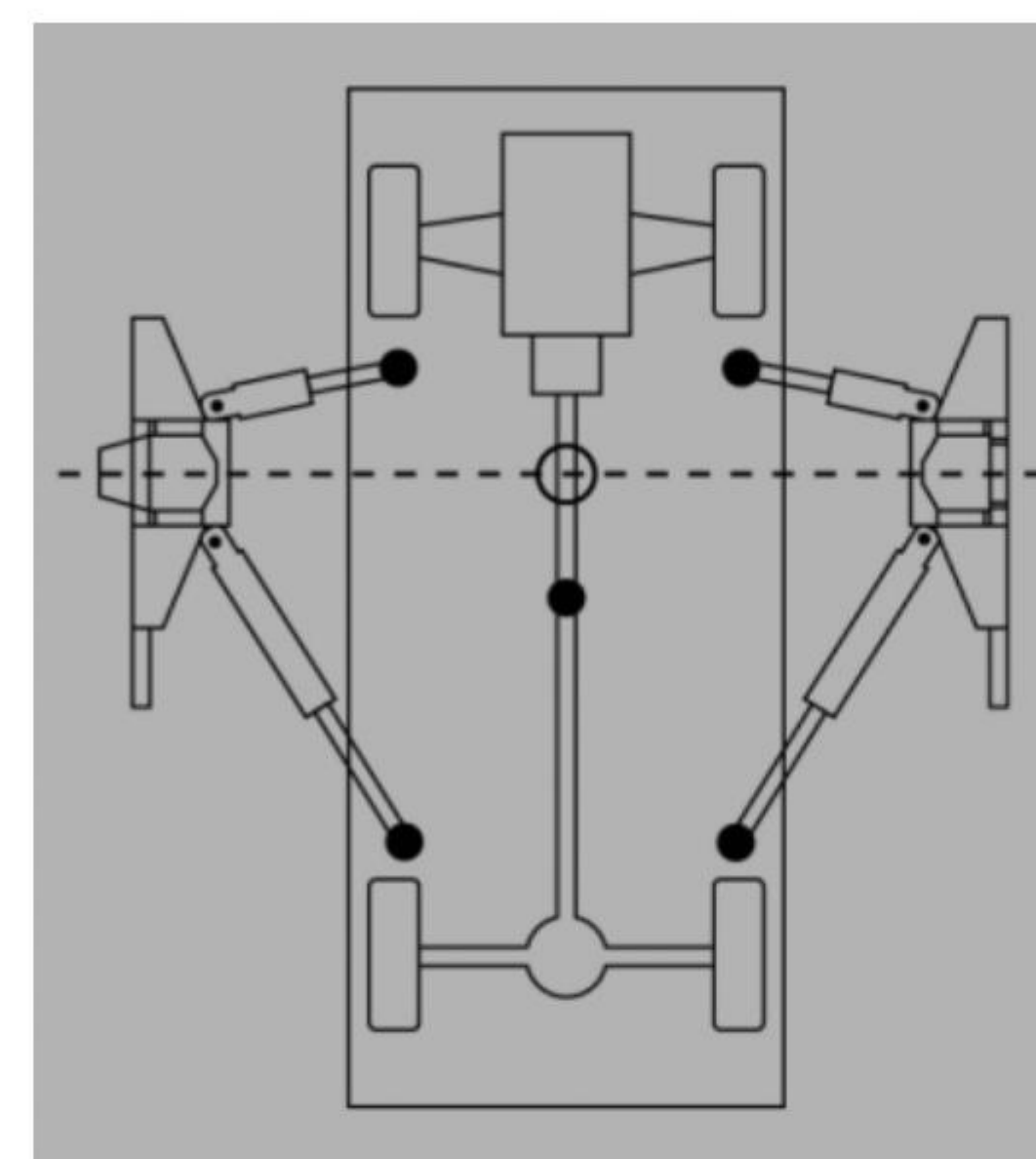

### 1.4 Safety Instructions for Commissioning

- The lift may be installed and commissioned by authorized service personnel only.
- The standard lift version may not be installed and commissioned in the vicinity of explosives or flammable liquids, outdoors or in moist rooms (e.g. car wash).

## 1.5 Safety Instructions for Operation

- ✚ Read the operating manual.
- ✚ Lift operation by authorized personnel over 18 years only.
- ✚ Always keep the lift and lift area clean and free of tools, parts, debris etc.
- ✚ Once the disk adapters contact the lift points, check arm restraints for engagement.
- ✚ After raising the vehicle briefly, stop and check the disk adapters for secure contact.
- ✚ Always lift the vehicle using all four adapters.
- ✚ Make sure the vehicle doors are closed during raising and lowering cycles.
- ✚ Closely watch the vehicle and the lift during raising and lowering cycles.
- ✚ Do not allow anyone to stay in lift area during raising and lowering cycles.
- ✚ Do not allow anyone on lift or inside raised vehicle.
- ✚ Only use the lift for its intended purpose.
- ✚ Comply with the applicable accident prevention regulations.
- ✚ Do not overload the lift. The rated load capacity is indicated on the lift nameplate.
- ✚ Only use the vehicle manufacturer's recommended lift points.
- ✚ After positioning the vehicle apply the parking brake.
- ✚ Use caution when removing or installing heavy components (center-of-gravity displacement).
- ✚ The main switch serves as emergency switch. In case of emergency turn to OFF position.
- ✚ Protect all parts of the electrical equipment from humidity and moisture.
- ✚ Protect the lift against unauthorized usage by padlocking the main switch.

## 1.6 Safety Instructions for Servicing

- ✚ Maintenance or repair work by authorized service personnel only.
- ✚ Turn off and padlock the main switch before doing any maintenance, or repair work.
- ✚ Work on pulse generators or proximity switches by authorized service personnel only.
- ✚ Work on the electrical equipment by certified electricians only.
- ✚ Ensure that ecologically harmful substances are disposed of only in accordance with the appropriate regulations.
- ✚ Do not use high pressure/steam jet cleaners or caustic cleaning agents. **Risk of damage!**
- ✚ Do not replace or override the safety devices.

## 1.7 Safety Features

### 1.7.1 Hold-to-run Type Control

The operator is required to hold the controls in the engaged position to raise or lower the lift.

### 1.7.2 Equalizing System

The lift is provided with distributing and connecting flow valve to ensure level movement of both carriages.

### 1.7.3 Collision Prevention Switch

A limit switch prevents collisions between cylinder top end and its slide block.

### 1.7.4 Pinch Point Protection

During lowering cycles the support arms lower down by hold to run, safety bar provided for pinch protection.

### 1.7.5 Automatic Arm Restraint

Once the lift is raised, the arm restraints are locked automatically to avoid any swivel under load.

### 1.7.6 Pipe Break Valve

The hydraulic cylinders are equipped with pipe break valves. They respond in case of rapid pressure drop (line break) to prevent sudden lowering movements.

### 1.7.7 Pressure Relief Valve

A pressure relief valve is used to limit the hydraulic working pressure to a maximum of 200bar.

## 2 Production information

### 2.1 Specifications



The properties indicated apply to lifts running at operating temperature (-10~40°C).

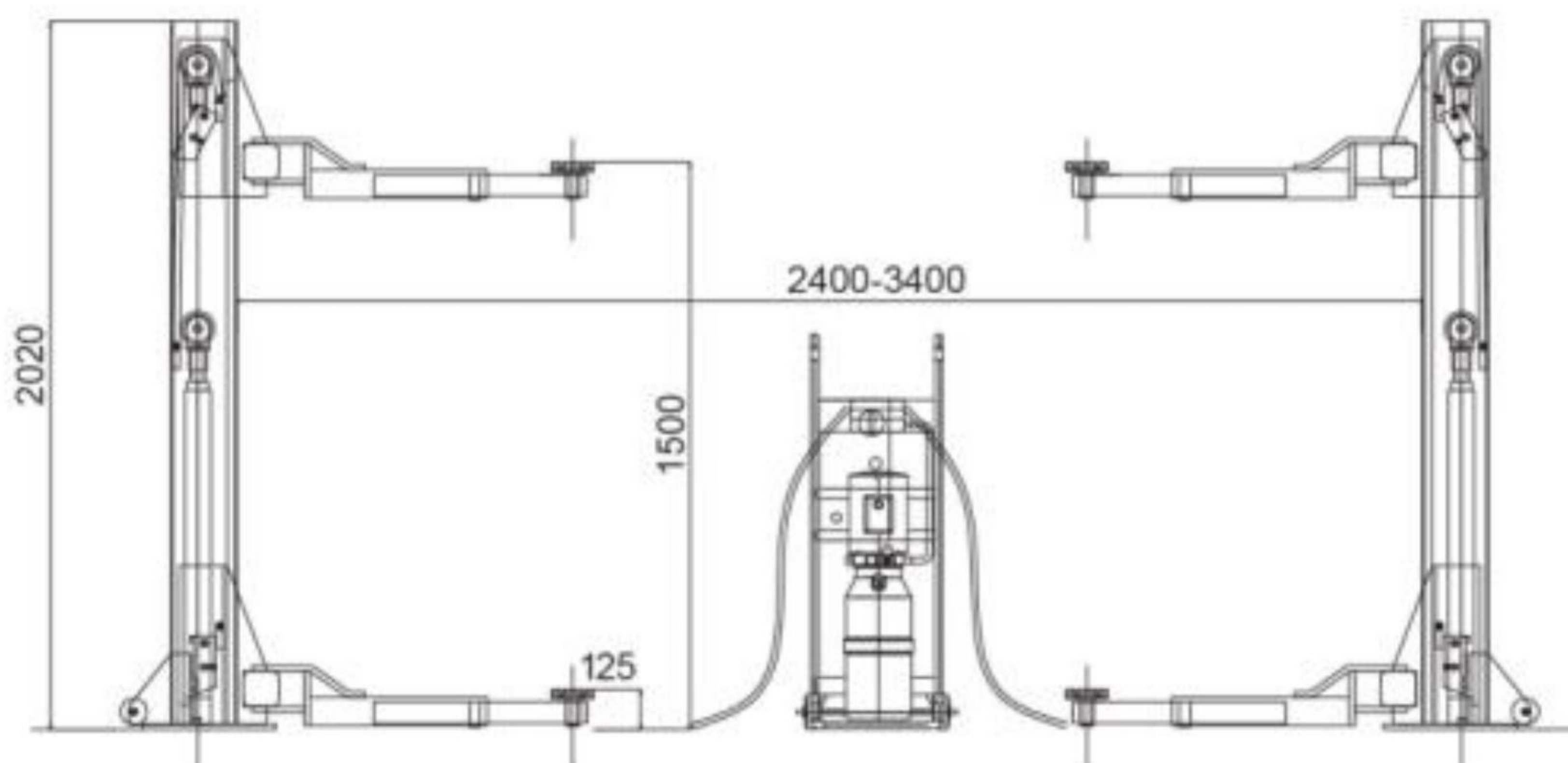

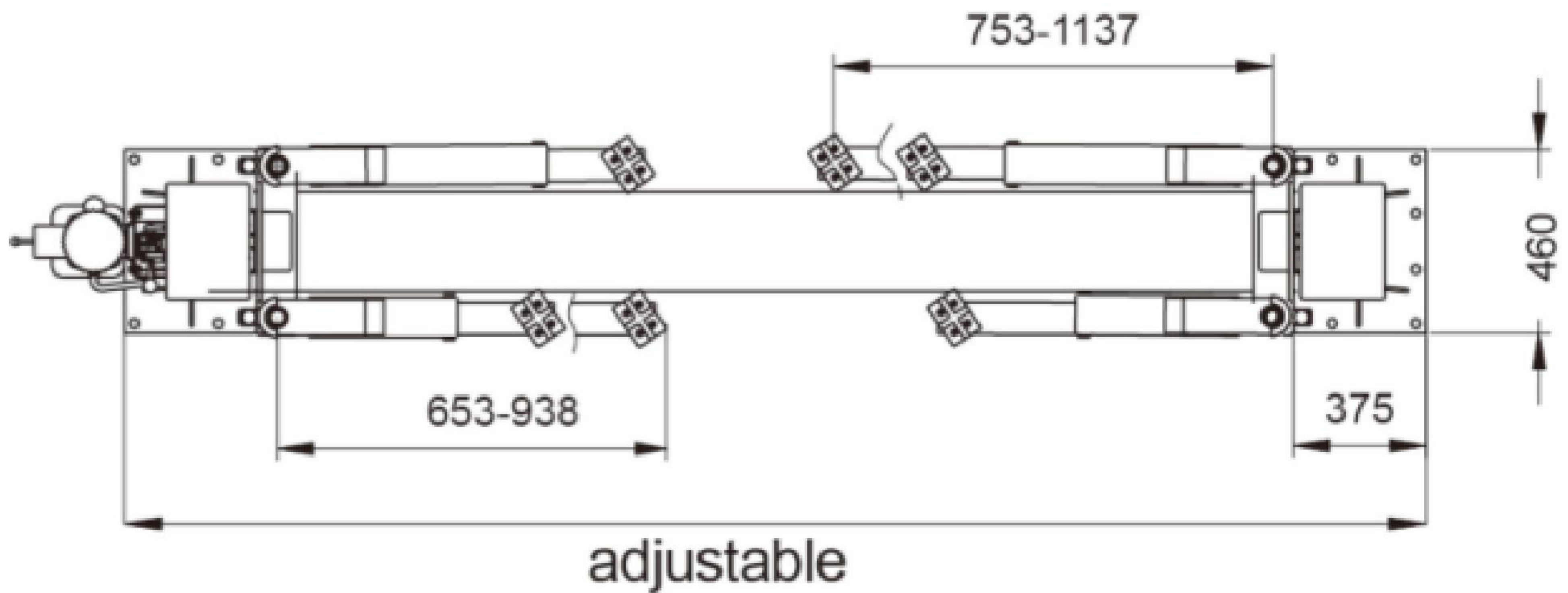















QJY3.0-E	
Type	Bottom bar
Capacity	3000kg
Lifting time	< 55s
Descent time	> 20s
Max. lifting height	1500mm
Min. lifting height	125mm
range of rubber pad	125~169mm
adjustable scope for arm	653-938mm 753-1137mm
size of outside column	adjustable, but <3400mm
size of inside column	Adjustable, but >2400mm
Power supply	220V/380V/415V/400V
Power	2.2 KW
Noise	≤70dB
Safety catch type	Manual two side release

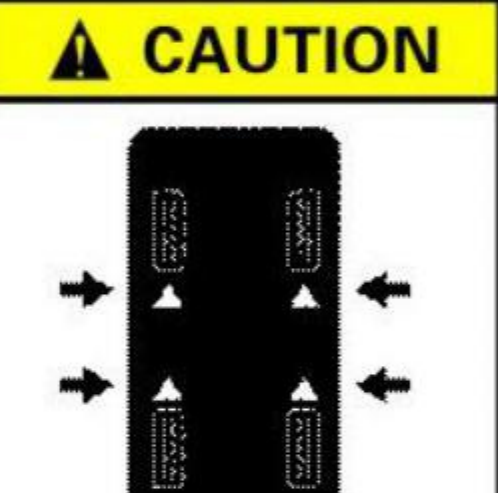

Specifications are subject to change without notice.

## 2.2 Safety warnings

The safety warnings of the machine are placed on the column.

 <p><b>▲ WARNING</b></p> <p>Clear area if vehicle is in danger of falling.</p>	 <p><b>▲ WARNING</b></p> <p>The vehicle's center of gravity should always be midway between the center points.</p>	 <p><b>▲ CAUTION</b></p> <p>Only those authorized and qualified personnel should operate the lifts.</p>	 <p><b>▲ CAUTION</b></p> <p>Exclude non-essential personnel from the lift area.</p>	<p><b>SAFETY INSTRUCTIONS</b></p>  <p>Read all safety, caution, and warning instructions before operating lifts.</p>	<p><b>SAFETY INSTRUCTIONS</b></p>  <p>Use applicable care and inspection for safe operation.</p>
 <p><b>▲ WARNING</b></p> <p>Away from the lift while raising and lowering it.</p>	 <p><b>▲ WARNING</b></p> <p>Avoid large weaving when the vehicle is raising and lowering.</p>	 <p><b>▲ CAUTION</b></p> <p>Always use vehicle lifting points specified by the manufacturer.</p>	 <p><b>▲ CAUTION</b></p> <p>Use safety stands when handling heavy items.</p>	<p><b>SAFETY INSTRUCTIONS</b></p>  <p>Do not use if any part is damaged or malfunctioning.</p>	<p>The sketch is same to the information words, also has mostly described the accidents all kinds of lifts maybe occur.</p>
 <p><b>▲ WARNING</b></p> <p>Do not override safety devices.</p>	 <p><b>▲ WARNING</b></p> <p>Keep hands and feet away from lift when descending.</p>	 <p><b>▲ CAUTION</b></p> <p>Height extensions will help ensure good contact.</p>	 <p><b>▲ CAUTION</b></p> <p>Lift capacity may be reduced by auxiliary adapters.</p>		

## 3. Packing, transport and storage



Only skilled personnel who are familiar with the lift and this manual shall be allowed to carry out packing, lifting, handling, transport and unpacking operations.

### 3.1 Packing

- ✚ The packing of the lift is delivered in following components:
  - ✚ Base unit packed in a steel frame, wrapped up in non-scratch material, including the all accessories.
  - ✚ Power unit packed in a carton box.
- (If requested, optional accessories are available to satisfy each customer's requirements).

### 3.2 Lifting and handling

When loading/unloading or transporting the equipment to the site, be sure to use suitable loading (e.g. cranes, trucks) and hoisting means. Be sure also to hoist and transport the components securely so that they cannot drop, taking into consideration the package's size, weight and centre of gravity and it's fragile parts.

### 3.3 Storage and stacking of packages

Packages must be stored in a covered place, out of direct sunlight and in low humidity, at a temperature between -10°C and +40°C.

## 3.4 Delivery and check of packages

When the lift is delivered, check for possible damages due to transport and storage; verify that what is specified in the manufacturer's confirmation of order is included. In case of damage in transit, the customer must immediately inform the carrier of the problem.

Packages must be opened paying attention not to cause damage to people (keep a safe distance when opening straps) and parts of the lift (be careful the objects do not drop from the package when opening).

## 4 Installation



Only skilled technicians must be allowed to carry out installation. Serious damage to people or lift can be caused by incorrect installations. *Forbidden to install outdoors.*

### 4.1 Space required

The lift must be installed on a level concrete floor, having minimum thickness of 20cm and an extension of at least 1.5m from anchoring points.

The lift installation concrete surface must be perfectly smooth.

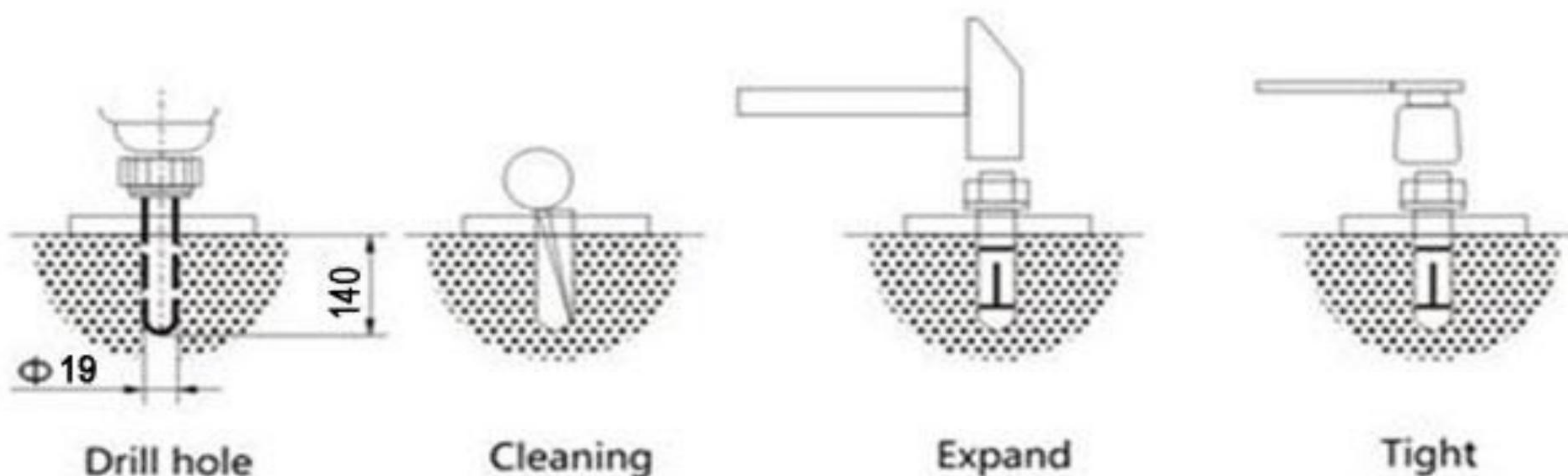
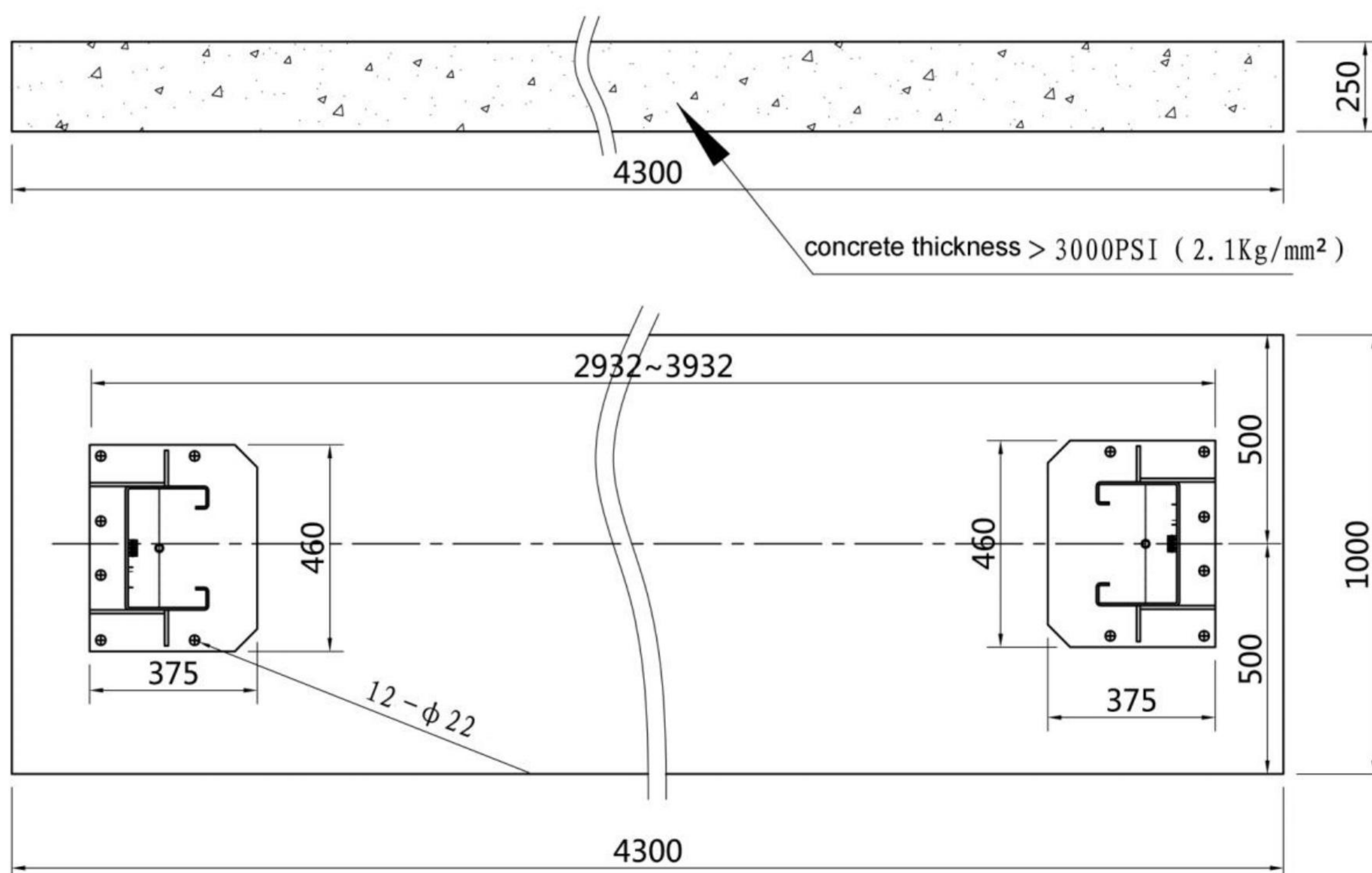



## 4.2 Installation steps

### Step One (determine location and marks with chalk on the floor):

1. Choose anyone post (Both of them are the same. After that, use a chalk line to layout a grid for the post locations and make an outline of the posts on the floor at each location.
2. Before proceeding, double check measurements and make certain that the bases of each column are square and aligned with the chalk line.

### Step Two (Mounting two columns):

1. Drill each anchor hole in the concrete using a rotary hammer drill. To assure full holding power, do not ream the hole or allow drill to wobble.
2. After drilling, remove dust thoroughly from each hole and make certain that the column remains aligned with the chalk line during this process.
3. If shimming is required, insert the shims as necessary under the base plate so that when the anchor bolts are tightened, the columns will be plumb.
4. With the shims and anchor bolts in place, tighten by securing the nut to the base then turning 2 -3 full turns clockwise. **DO NOT use an impact wrench for this procedure.**
5. Position the other column at the designated chalk locations and secure to the floor following the same procedures as outlined in step 1, 2, 3, 4.

### Step Three (Connecting the hydraulic pipe and installing the limit switch):

1. Installing the limit switch on top position of post.



2. Connecting hydraulic pipe according the hydraulic drawing. 1 and 2 should connect with two hydraulic cylinders, 3 should connect with pump.

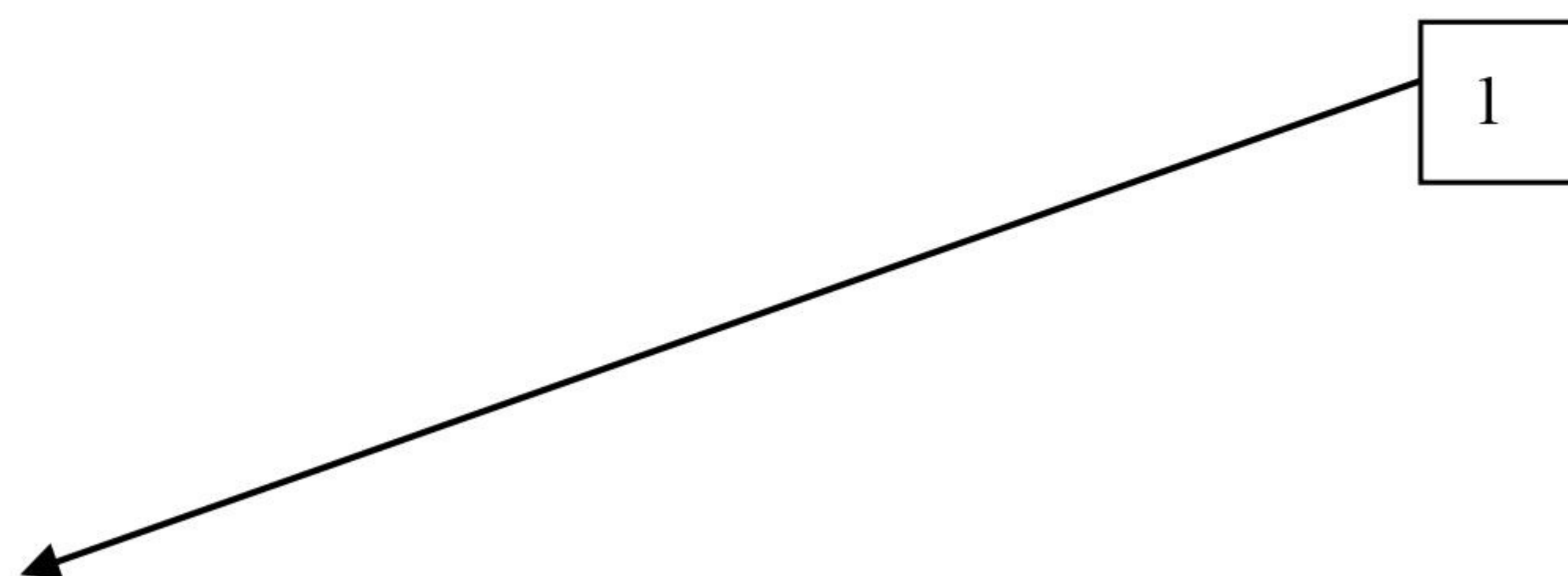

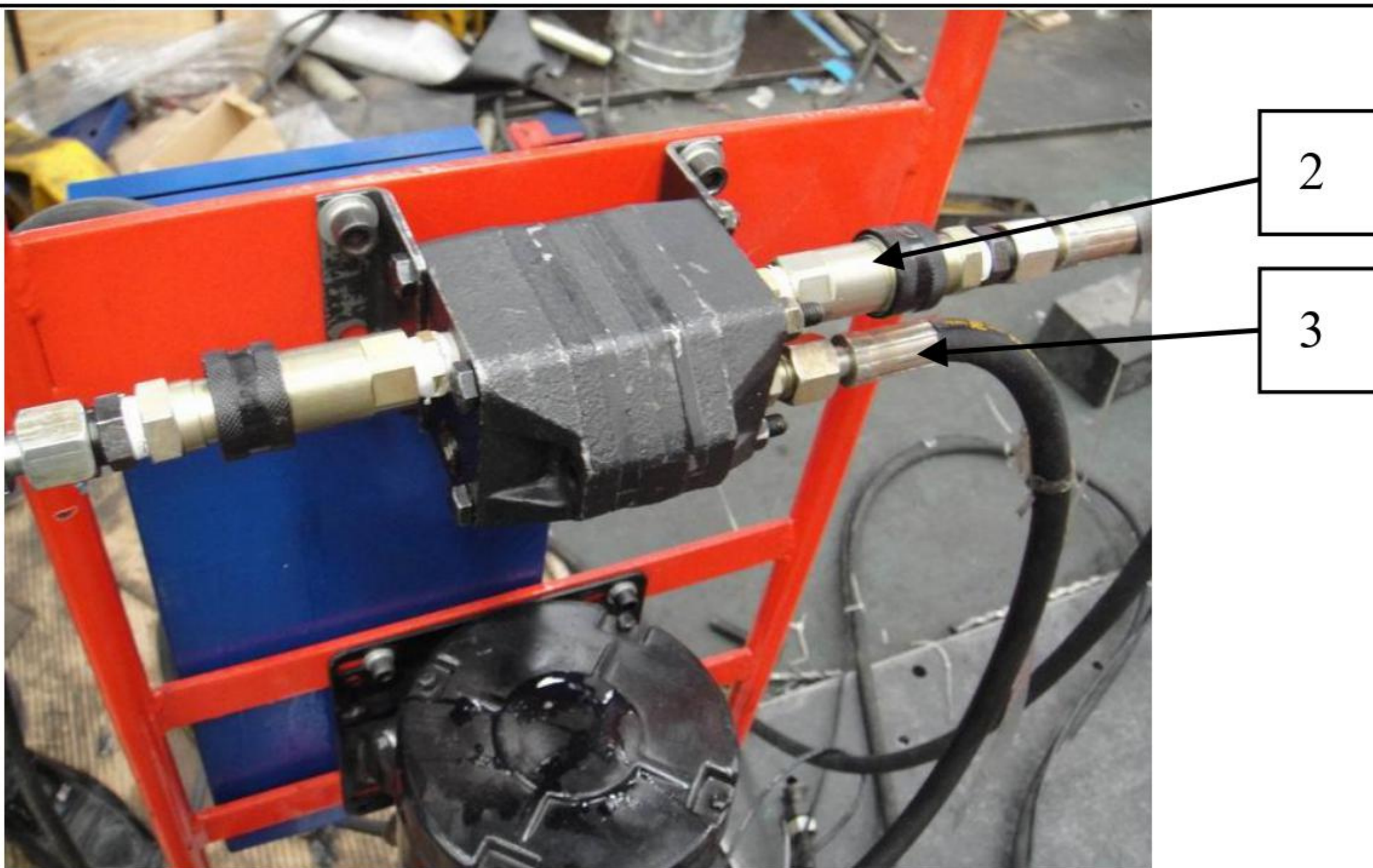

Make sure the funnel used to fill the power unit is clean in summer and winter you should change the oil.

## Step Four (Lifting arms):

The arms are as below picture showing.



## 5 Operation



Lift operation by authorized personnel over 18 years only.  
Apply the parking brake after positioning the vehicle on the lift.  
Do not allow anyone to stay in lift area during raising and lowering cycles.  
Closely watch the vehicle and the lift during raising and lowering cycles.  
Observe the rated load capacity and load distribution.  
Do not allow anyone to climb on lift or stay inside vehicle.  
After raising the vehicle briefly, stop and check adapters for secure contact.  
Once the disk adapters contact the lift points, check arm restraints for engagement.  
Make sure the vehicle doors are closed during raising and lowering cycles.



In case of defects or malfunctions such as jerky lift movement or deformation of the superstructure, support or lower the lift immediately.  
Turn off and padlock the main switch. Contact qualified service personnel.

### 5.1 Controls

#### 5.1.1 Control Unit

Unloading handle



Unloading handle: lower the lift, hold-to-run type control.

## 5.1.2 Arm restraint



Once the disk adapters contact the lift points, check arm restraints for engagement. If necessary, slightly move the arms until the gear segments mesh. Never unlatch the arm restraints when the lift is under load.

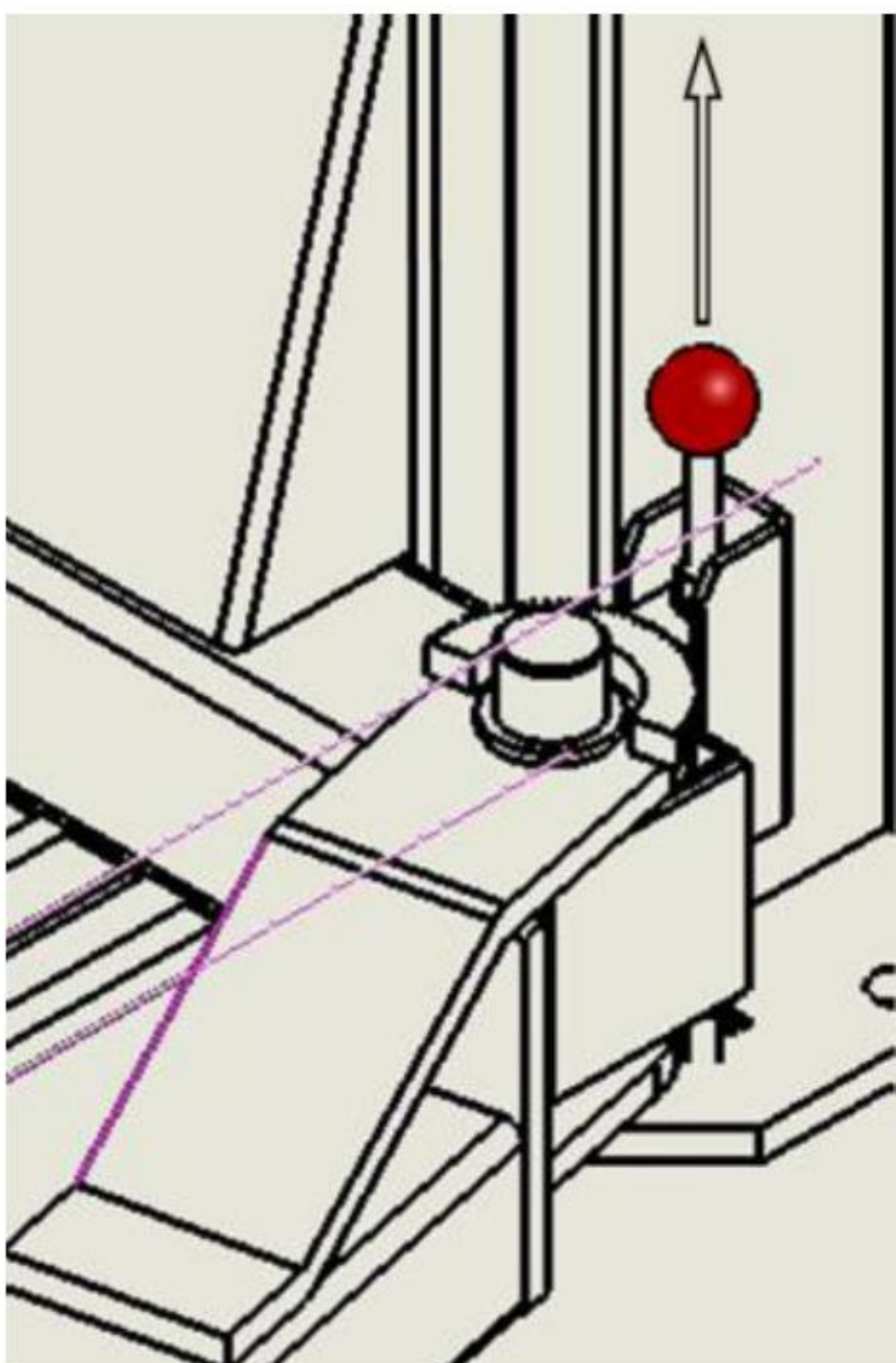

Each support arm is provided with an automatic arm restraint which unlatches automatically when the lift is in bottom position.

When the carriages are in a raised position, the arm restraint can be disengaged by pulling the pull-handle.

## 5.2 Operation

### 5.2.1 Preparations

1. Fully lower the lift and swing the arms to full drive-through position.
2. Slowly position vehicle midway between adapters. Apply the parking brake.
3. Swing and telescope arms as required to position adapters under vehicle manufacturer's recommended lift points.
4. Turn the disk adapters that they evenly contact all four lift points.



5. Leave vehicle and remain clear of lift.



Always lift the vehicle using all four adapters.

### 5.2.2 Raising



During raising and lowering cycles: Closely watch the vehicle and the lift, do not allow anyone to stay in lift area and make sure the vehicle doors are closed. Once the disk adapters contact the lift points, check arm restraints for engagement. After raising the vehicle briefly, stop and check adapters for secure contact.

- Push the plug and the lift is ready for operation.
- Push and hold the green button until the lift reaches desired height, the lift stops once button is released or top travel limit is reached.

### 5.2.3 Vehicle in Raised Position

- Observe all accident prevention regulations.
- Do not allow unauthorized persons to stay under the raised vehicle.
- Avoid rocking of vehicle.
- Keep lift free of tools, parts, etc.
- Fasten the vehicle to the support arms using lashing straps when removing or installing heavy components.

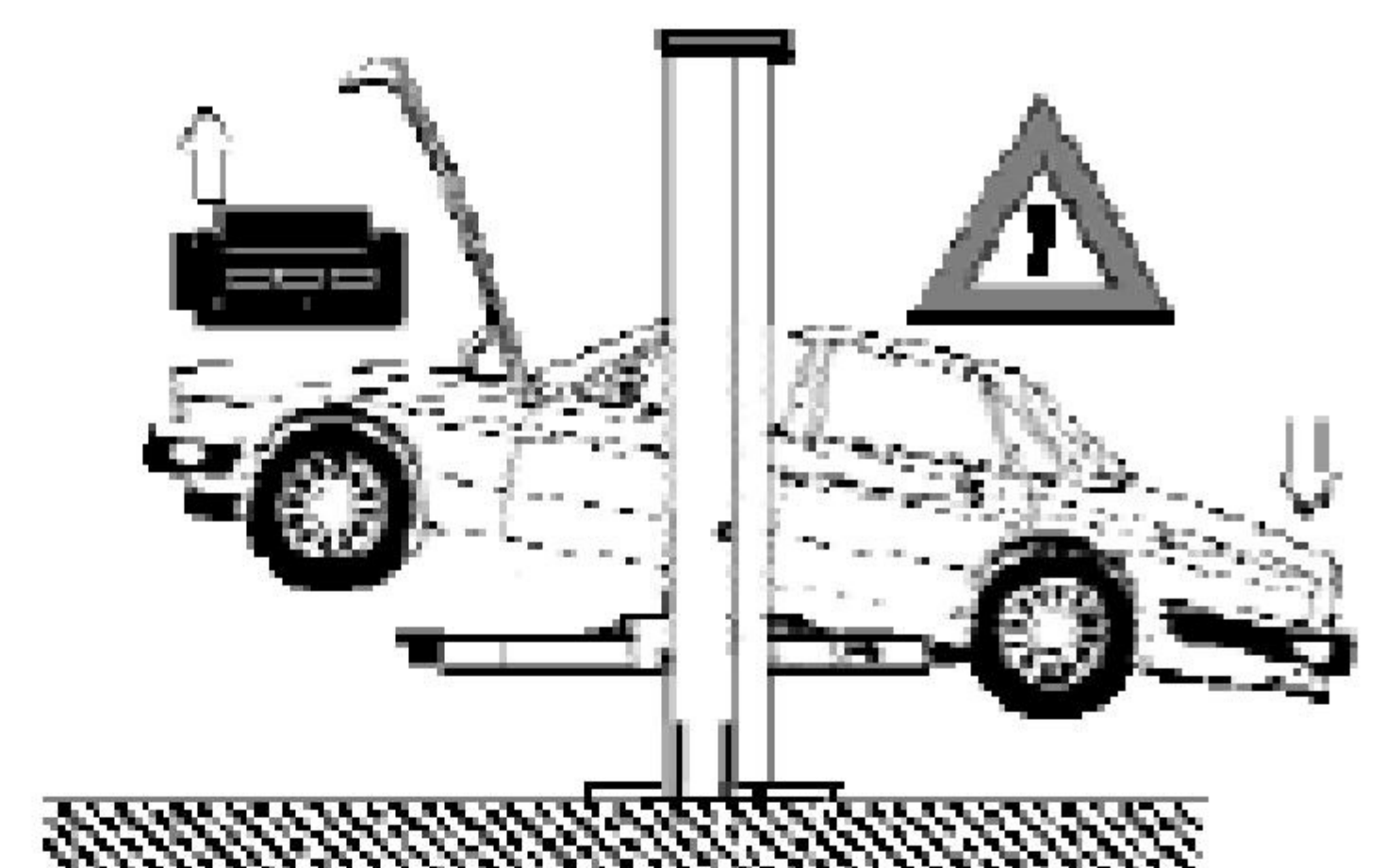

### 5.2.4 Set on Locks

Use the unloading handle to set the lift on the nearest mechanical locks. In this way the vehicle can be securely fixed when the vehicle is in a raised position.

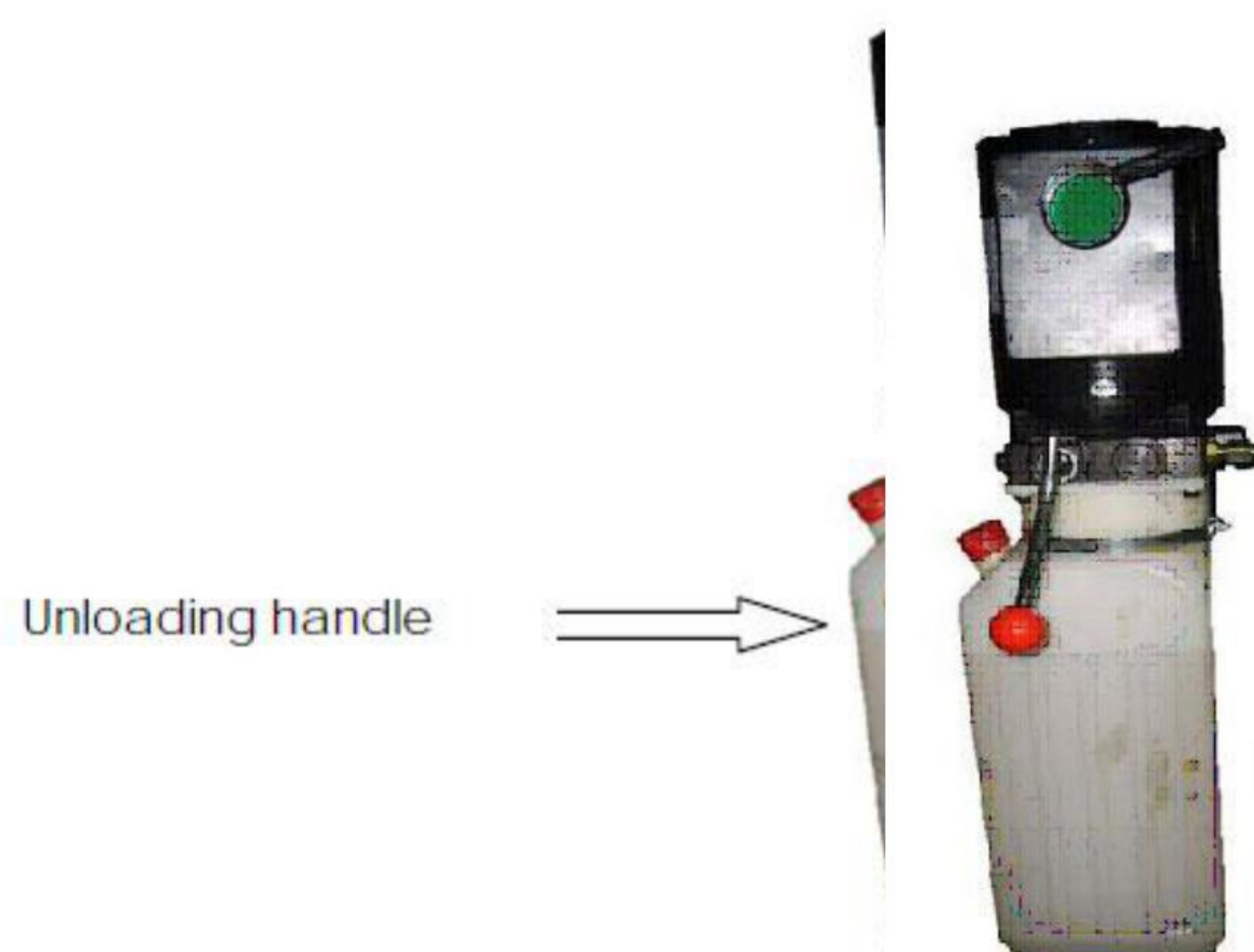

### 5.2.5 Lowering



During raising and lowering cycles: Closely watch the vehicle and the lift, do not allow anyone to stay in lift area and make sure the vehicle doors are closed.

1. Remove tools, stands or other objects from lift bay.
2. Push the plug and the lift is ready for operation.
3. If the safety plate is in the engaged position, briefly raise the lift before lowering.
4. Pull the unlocking steel wire at both columns.

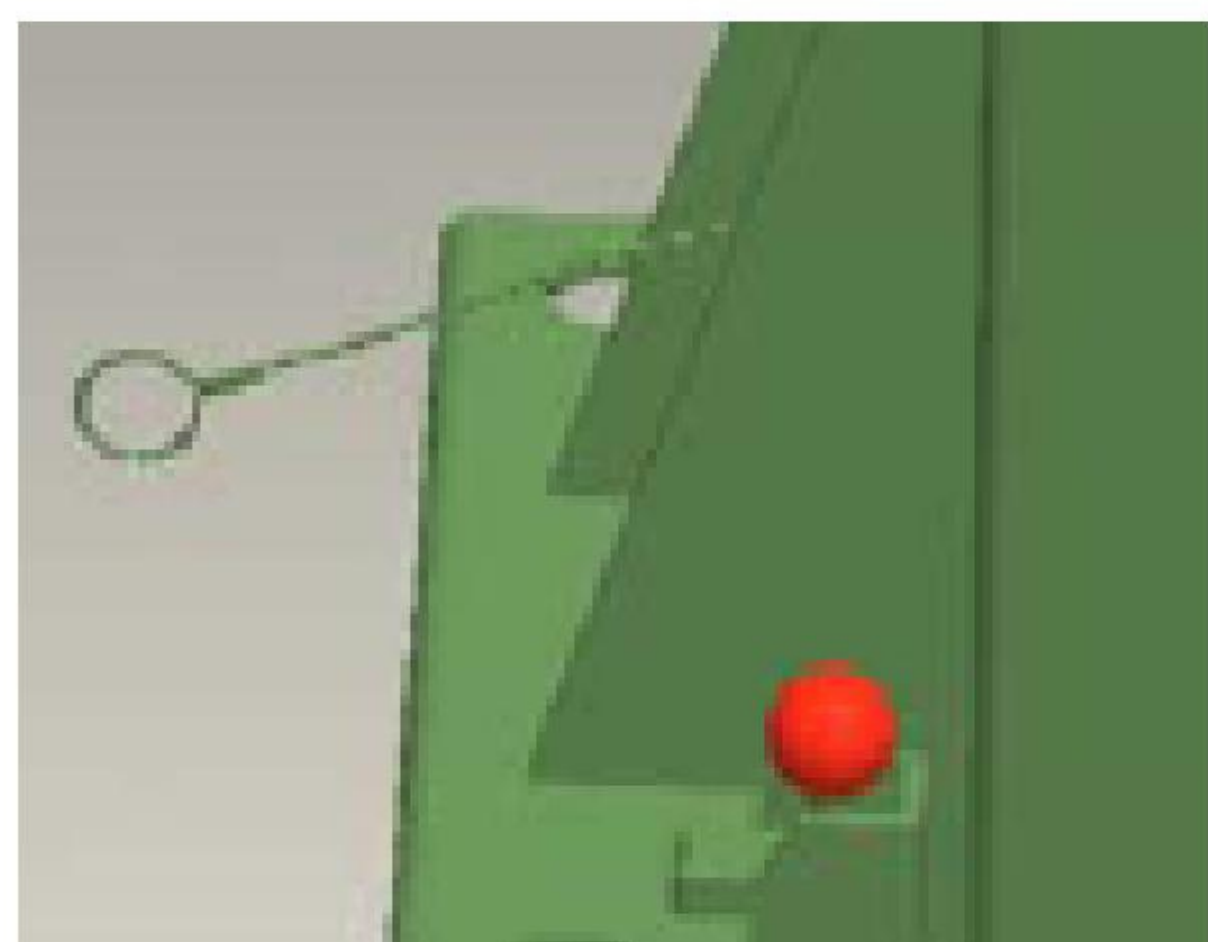

5. Press the unloading handle until lift reaches desired height, the lift stops once the unloading handle is released. During lowering cycles the support arms automatically stop at a height of 110mm above bottom position.
6. To lower the arms completely, release the unloading handle.
7. Swing arms to full drive-through position and drive the vehicle off the lift.

### 6. Maintenance



Authorized personnel only!  
Pull out the plug before servicing the lift.



The maintenance intervals indicated below apply to average workshop use.  
The lift should be inspected more frequently for severe use applications

#### 6.1 Maintenance schedule

Establish a periodic preventive maintenance procedure to ensure trouble free operation and long service life.

Interval	Maintenance to be performed on	Items
1 week	Support arms/Disk adapters	<ul style="list-style-type: none"> <li>● Check rubber pads for wear</li> <li>● Check arm restraints for engagement</li> </ul>
6 months	Greasing points	Check and lubricate as required: <ul style="list-style-type: none"> <li>● Slide tracks</li> <li>● Arm extensions</li> <li>● Threads of disk adapters</li> </ul>
	Nuts of anchor bolts	Check all nuts for correct torque and retighten them as required
12 months	Hydraulic system	<ul style="list-style-type: none"> <li>● Check fluid level.</li> <li>● Check tightness of hoses and fittings.</li> </ul>

### 6.2 Annual inspection

We recommend having the lift inspected by qualified service personnel every 12 months.

### 6.3 Maintenance by the operator

#### 6.3.1 Hydraulic system

- Checking the Fluid Level

The fluid level can be read through the transparent reservoir at the power unit.

With the lift fully lowered, the fluid level must reach above the min level.

- Once a year check the fluid level with the lift fully lowered and add fluid as required.
- Visually check all hydraulic hoses for tightness.



The hydraulic fluid must be replaced periodically depending on aging, soiling and water absorption. It is recommended to replace the pressure hoses as required, but after six years at the latest.

#### 6.3.2 Greasing points

- Slide tracks



The slide tracks inside the columns should be greased every six months (or more frequently in case of noise generation).

Slightly greases the slide tracks over their whole length using a brush.

- Arm extensions

1. Every six months check the support arm extensions for smooth operation.
2. Grease as required.

#### 6.3.3 Operational and wear checks

- Rubber Pads of Disk Adapters

1. Weekly check the rubber pads for wear.
2. Replace them as required.



- Arm Restraints

Weekly check the arm restraints for secure engagement.

#### 6.3.4 Lift stability

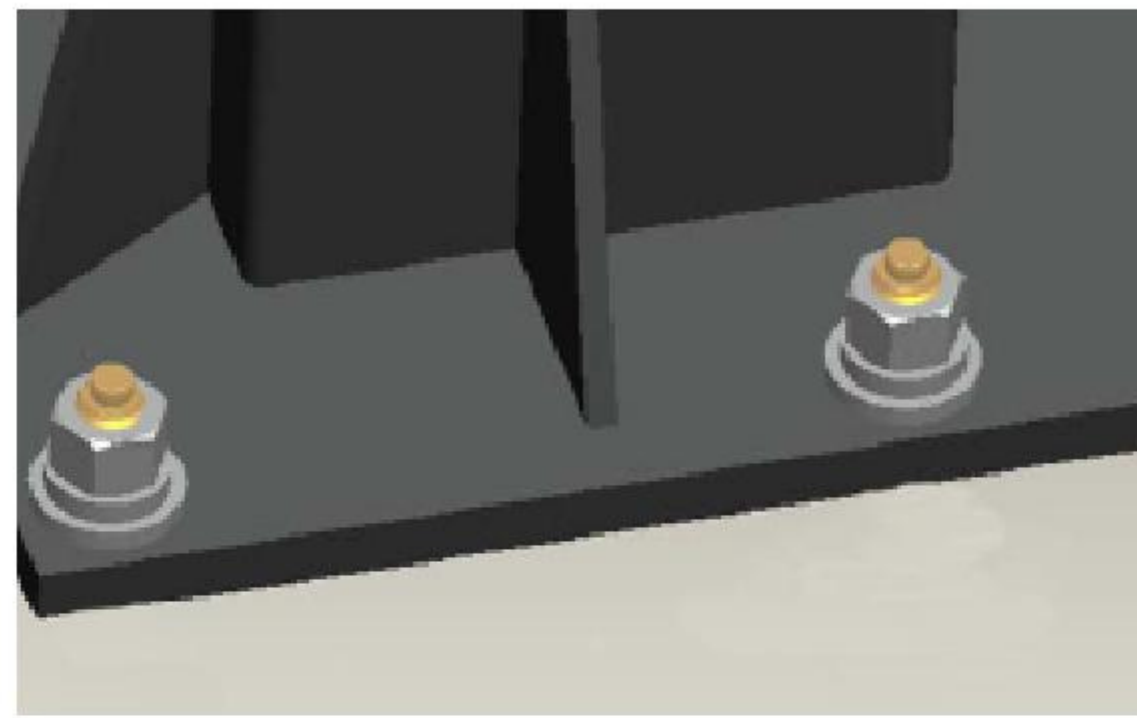
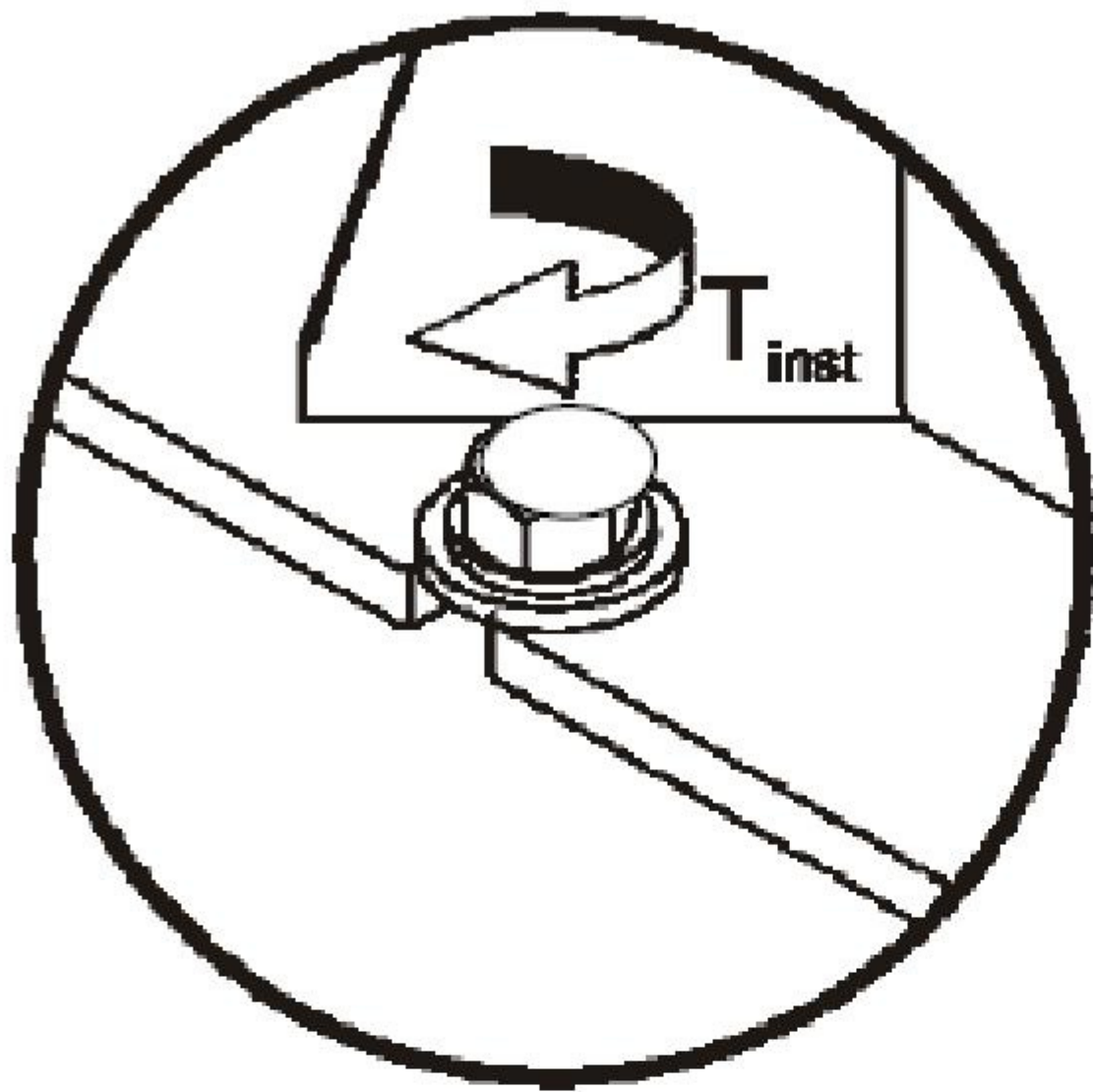

- Every six months check the nuts of all anchor bolts for correct installation torque  $T_{inst}$ .
- Retighten them as required.

Installation Torque $T_{inst}$	80Nm
--------------------------------	------

## 6.4 Cleaning



Do not use high pressure/steam jet cleaners or caustic cleaning agents.  
Risk of damage!

- Periodically wash off aggressive substances and treat the lift with oil or wax spray.
- Repair damage to the paintwork immediately to prevent corrosion. The RAL number is available through the manufacturer.

## 7. Trouble shooting

Trouble	Diagnosis	Remedy
Lift does not respond	Plug didn't push on	Push the plug
	Main fuses defective	Replace the main fuses
Motor starts up, pressure build-up insufficient to raise load	Lowering screw open	Close lowering screw
	Lowering valve permanently open	Contact service
	Hydraulic system leakage	Remove leakage
	Low fluid level	Check fluid level, add fluid as required
	Load on lift too heavy	Reduce load, observe rated load capacity
Level difference between carriages too big	Equalizing cables maladjusted	Contact service
Lift cannot be lowered	Latch release defective	Contact service

## 8 Disposal

For disposal at end of working life, drain hydraulic fluid and dispose of fluid and other components through the normal industrial scrap route.

No hazardous materials are used.

9 Attached drawings

9.1 Electrical drawing

9.2 Hydraulic drawings

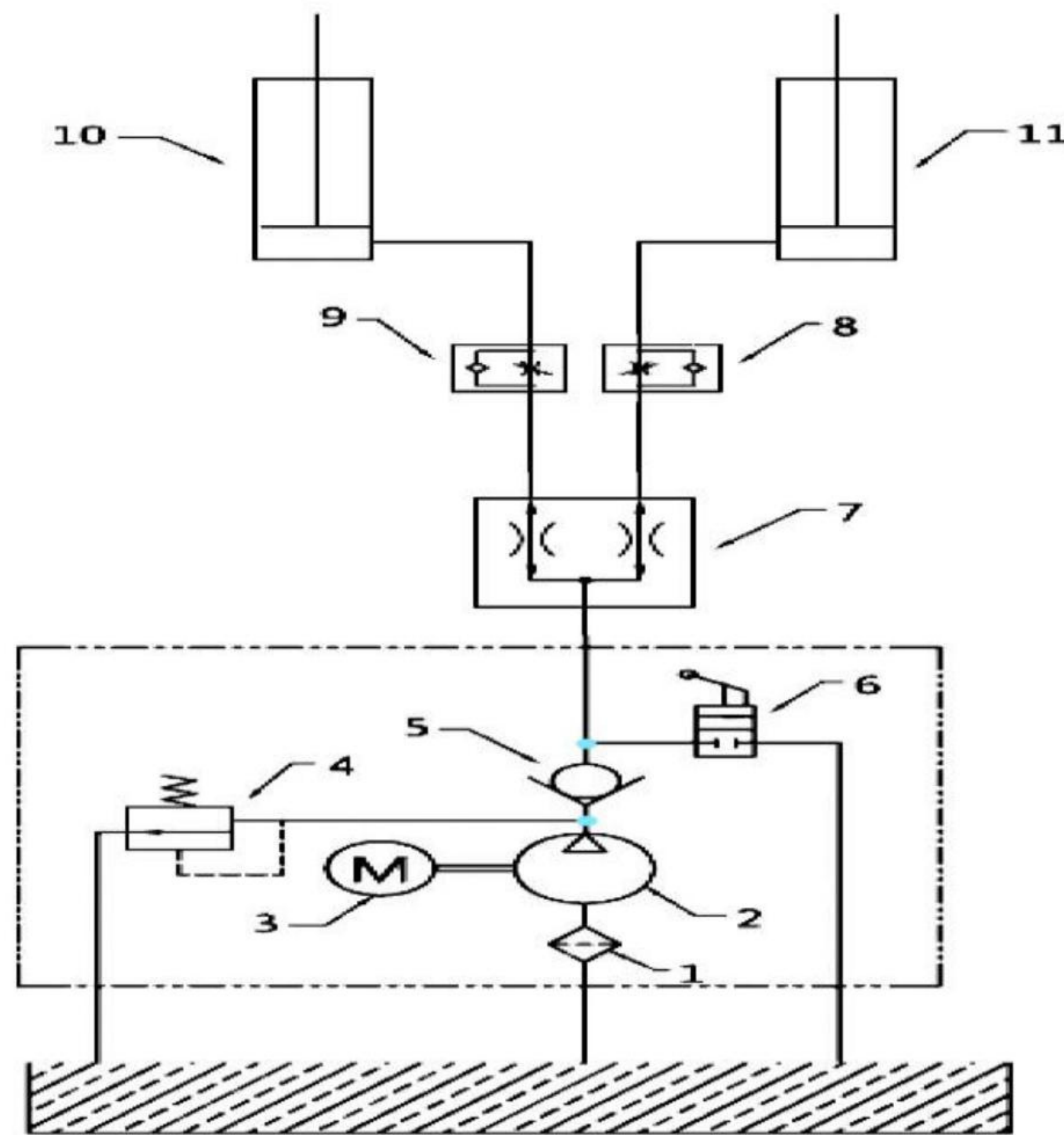

9.3 Explosive view

