

INSTALLATION INSTRUCTIONS

Metal Garage Shed 21'x19'

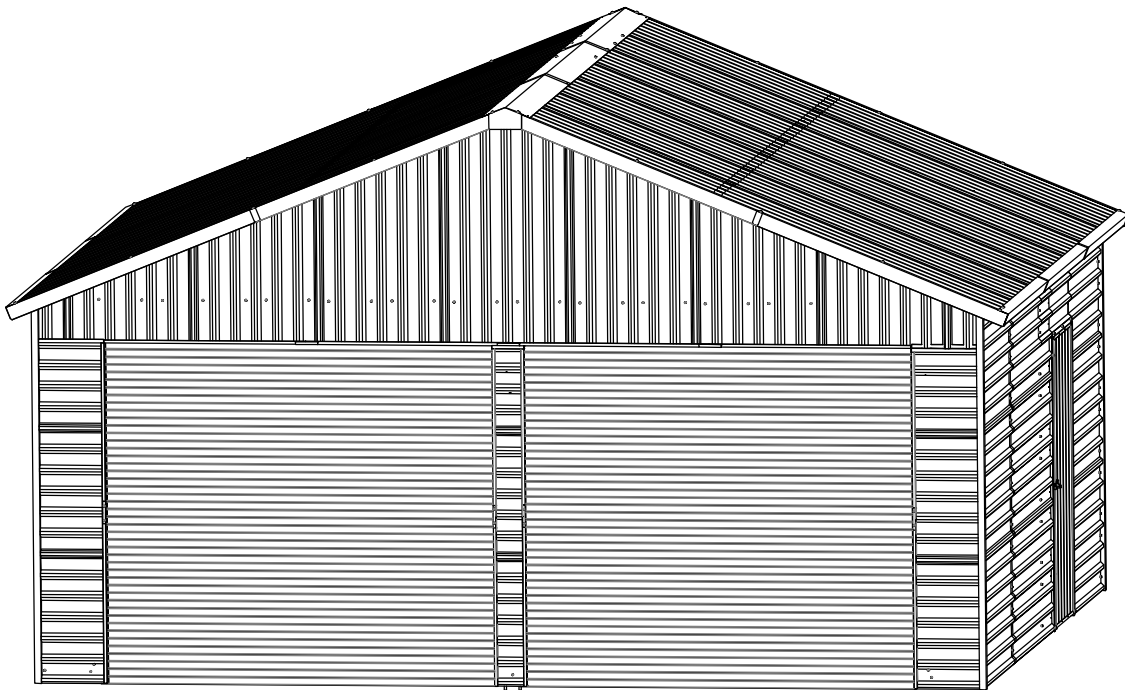

WARNING







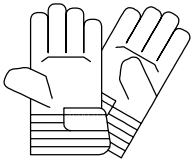

Please read the instructions **COMPLETELY** before assembly.

This metal shed might not be suitable for local bylaws or weather conditions. It is the owner's responsibility to ensure the installation and use of this building are permitted by local authorities. Some municipalities may require engineering drawings to be submitted. It is the owner's responsibility to hire an engineer to submit drawings if required.

BEFORE YOU START

Items Required:

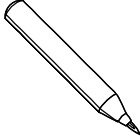
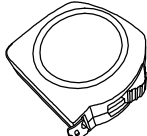































Safety Gear				
	gloves	Safety Glasses	Shoes	Riveting Gun
Tools				
	Power drill	Screw drive	Pencil	Tape Measure

- Clear a working area to allow access on 4 sides. A raised work surface will make assembly easier.
- Please choose a dry and calm day to start assembly. Do not attempt installation in rainy or windy day.
- **Keep roof clear of leaves and snow with long handled, soft-bristled broom. Heavy amounts to snow on roof can damage building, making it unsafe to enter.**
- All parts are identified so when working through the instructions page by page the diagrams show where each part is positioned.
- Before starting, to avoid any accidental injury, we recommend the use of gloves to protect your hands, safety glasses to protect your eyes and shoes or boots to protect your feet.
- Many of the holes have been pre-punched, to allow fixing using self-tapping screws or rivets, where additional holes are required a drill bit is included.
- Please keep children away from your construction site.
- Most assembly can be completed by one person, assistance may be needed when you reach the erection stage.
- Cleaning should be performed as often as is required to remove any dirt, salt, and pollutants.
- Please note: Some local government authorities have rules & regulations on shed installation and you may need approval to erect this shed.















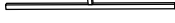
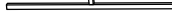
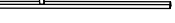
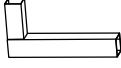
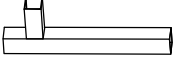









STEPS:

1. Unpack all components from the carton and lay outside your work area and check parts against the part list on the next page.
2. Work through assembly instructions Page by Page
3. When completed place shed in position and anchor securely to the ground.
4. Clean up all metal pieces, rivets and screws.

























PART LIST

Picture	Name	QTY	Check	Picture	Name	QTY	Check
	P1A	8			P1B	4	
	P2A	10			P2B	4	
	P3A	1			P4A	2	
	P4B	1			P5A	4	
	P5B	2			P6A	2	
	P6B	1			P7A	14	
	P8A	14			P9A	2	
	P9B	1			PD1	1	
	PA1	2			PA2	2	
	PA3	2			PA4	2	
	PA5	2			PB4	2	
	PB3	2			PB2	2	
	PB1	2			P2B1	1	
	FG1	6			FG2	4	
	FG3	8			FG4	1	
	FD1	2			FD2	1	

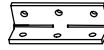
PART LIST

Picture	Name	QTY	Check	Picture	Name	QTY	Check
	FD3	1			FDU1	1	
	FDU2	2					
	A1A	2			A1B	2	
	A2A	2			A2B	1	
	A3A	2			A3B	2	
	A3C	2			A3D	1	
	A1895	18			A905	2	
	A2150	3			AS2	10	
	AS4	5			AS3	10	
	A1840	1			A1225	2	
	B1490	4			B270	2	
	B1432	12			B1467	12	
	MSG	2			MSH	1	
	L1A	8			L1B	6	
	Z1	4			Z2	2	

PART LIST

Picture	Name	QTY	Check	Picture	Name	QTY	Check
	W1	8			TE2	1	
	R1A	3			TE1	2	
	JA	11			S1	28	
	S12	1398			S13	60	
	L3	18			L1A	6	
	LGG	2			S7	18	
	S16	18			MSA	2	
	C3	30			C22	28	
	C52	6			C62	12	
	C72	14			SH1	2	
	S11	14			H1	1	
	S15	4			CG1	1	
	Waterproof tape	1			C12	4	

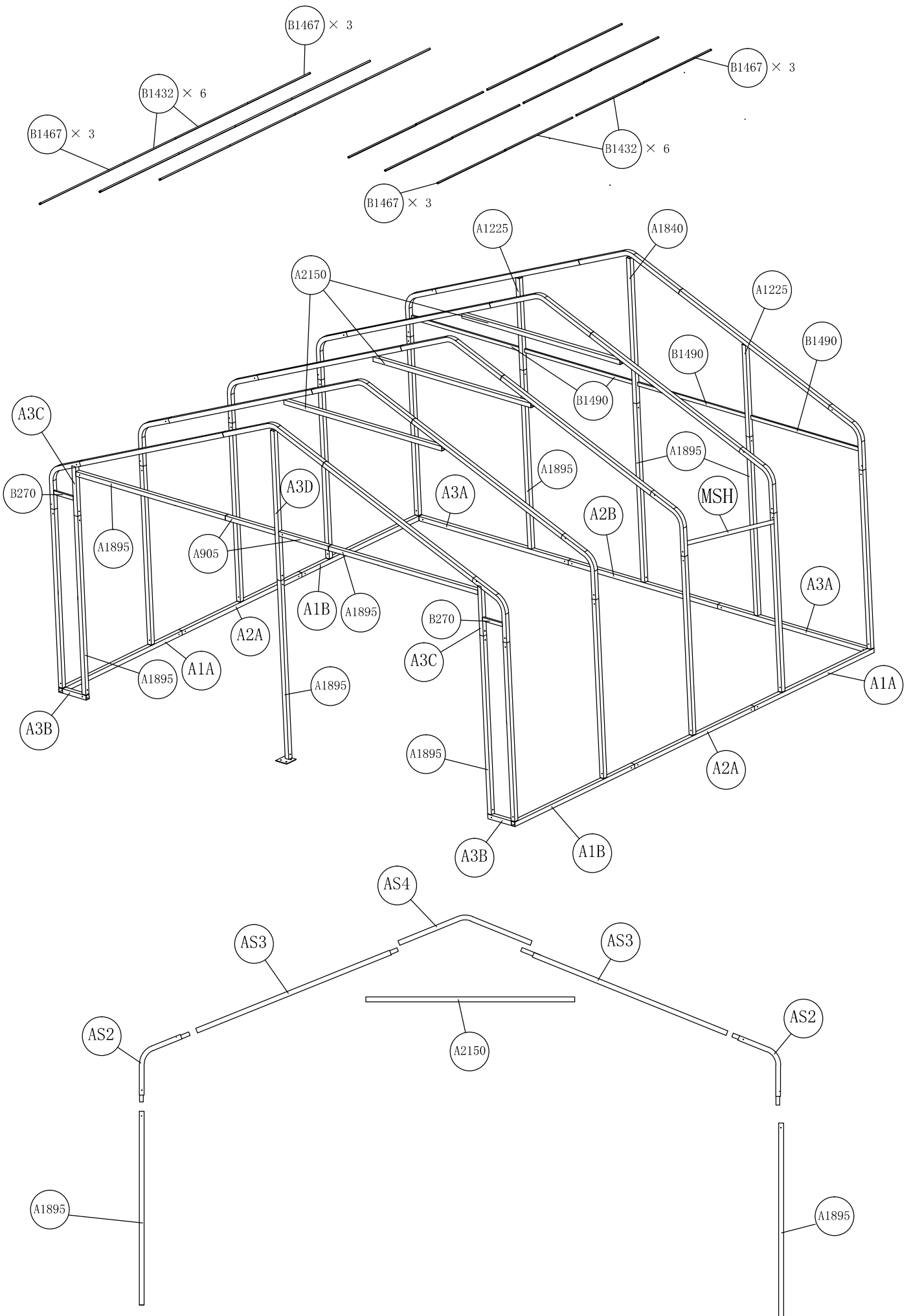

FRAME ASSEMBLY

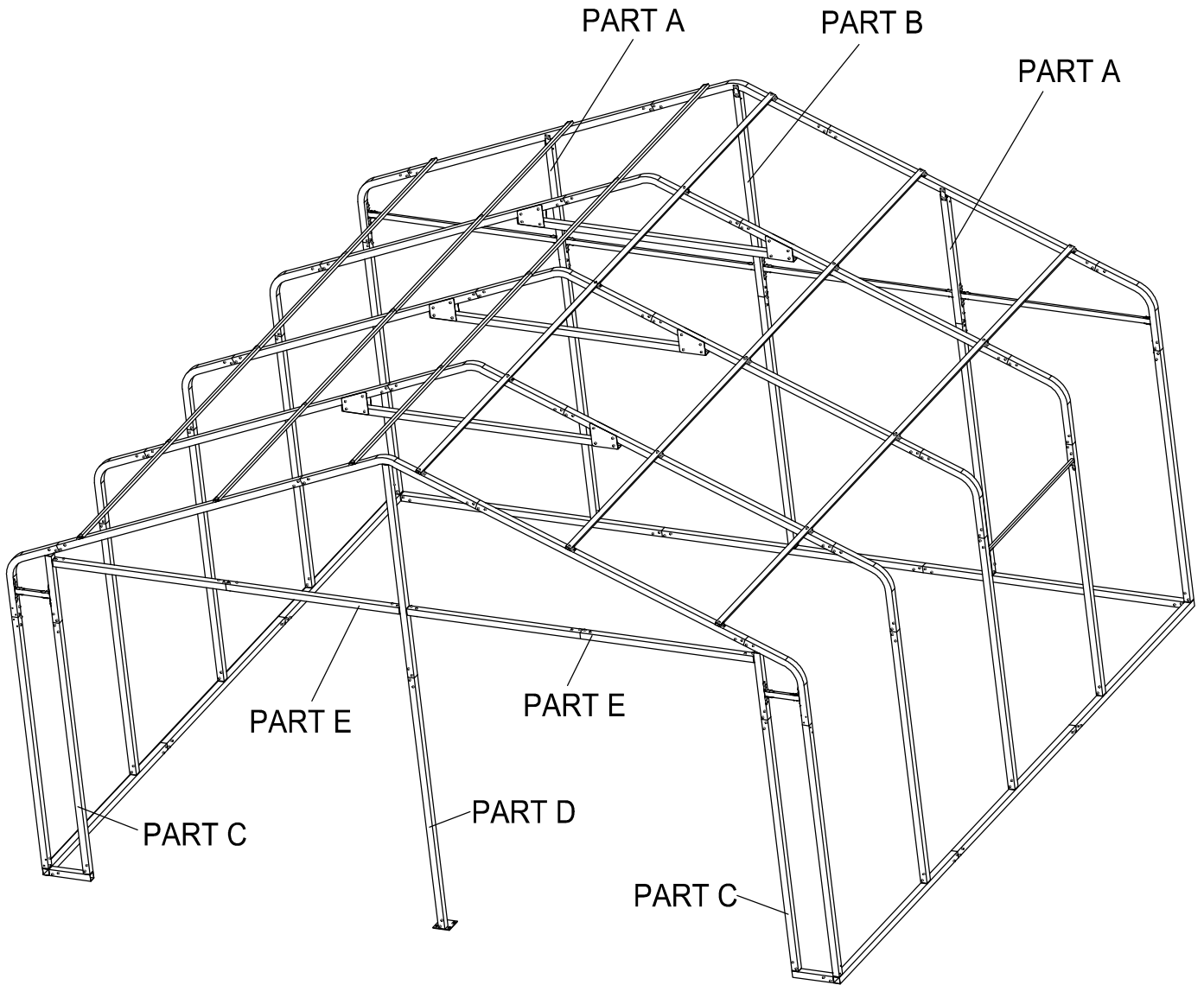

BEFORE WELDING

	A1895	8		A1225	2		A3C	2		A3D	1
	A905	2		A1840	1		S12	28			

STEP 1

when you install the square tube, it will be much easier to adjust the angel first.

STEP 2

STEP 3

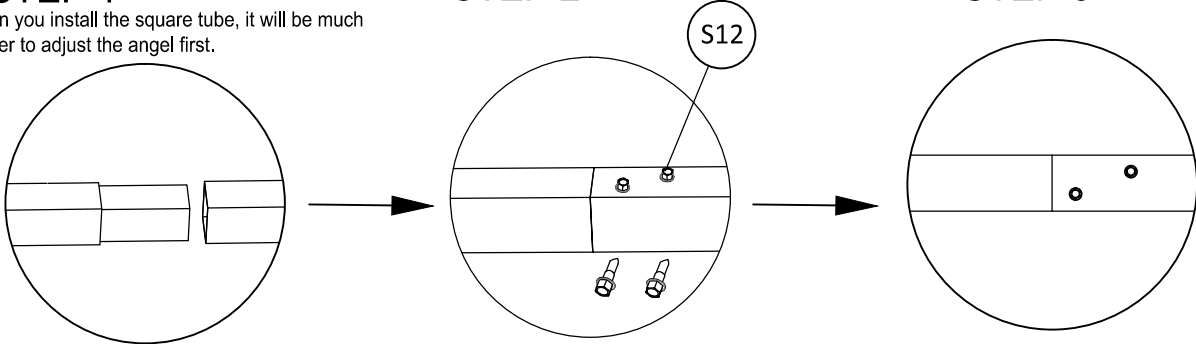

PART A × 2PCS



PART A = 3020mm

PART B × 1PCS



PART B = 3635mm

PART C × 2PCS

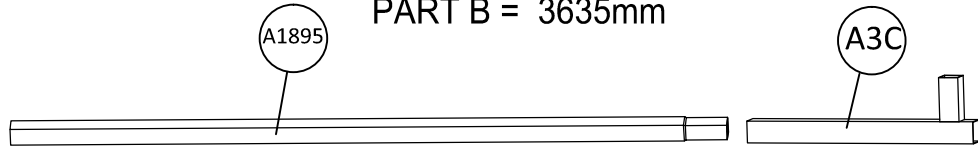

PART C = 2525mm

PART D × 1PCS

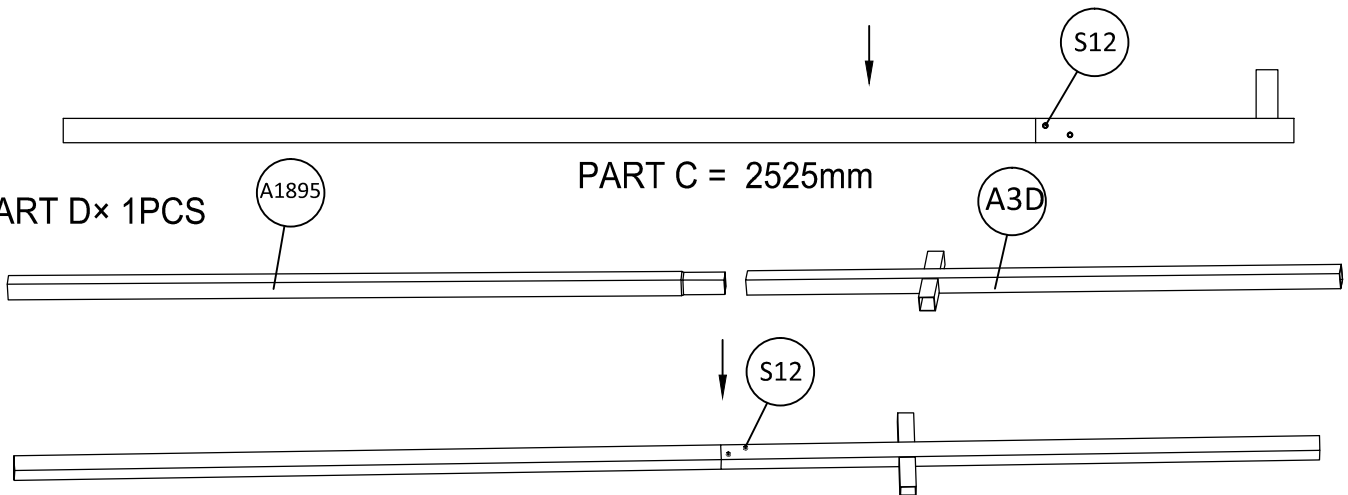

PART D = 3685mm





PART E × 2PCS



PART E = 2700mm



FRAME ASSEMBLY - BACK WALL

STEP 1

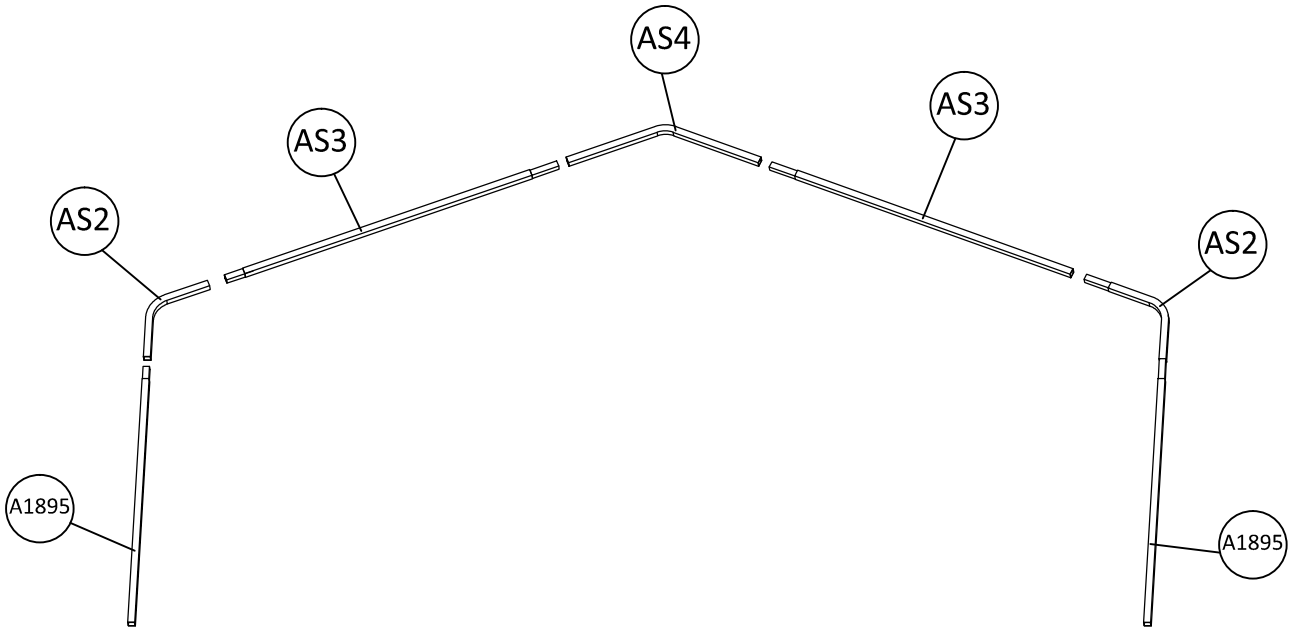
	A1895	2		AS2	2		AS3	2
	AS4	1		S12	24			



STEP 2

	B1490	1		C22	4		S12	16
---	-------	---	---	-----	---	---	-----	----



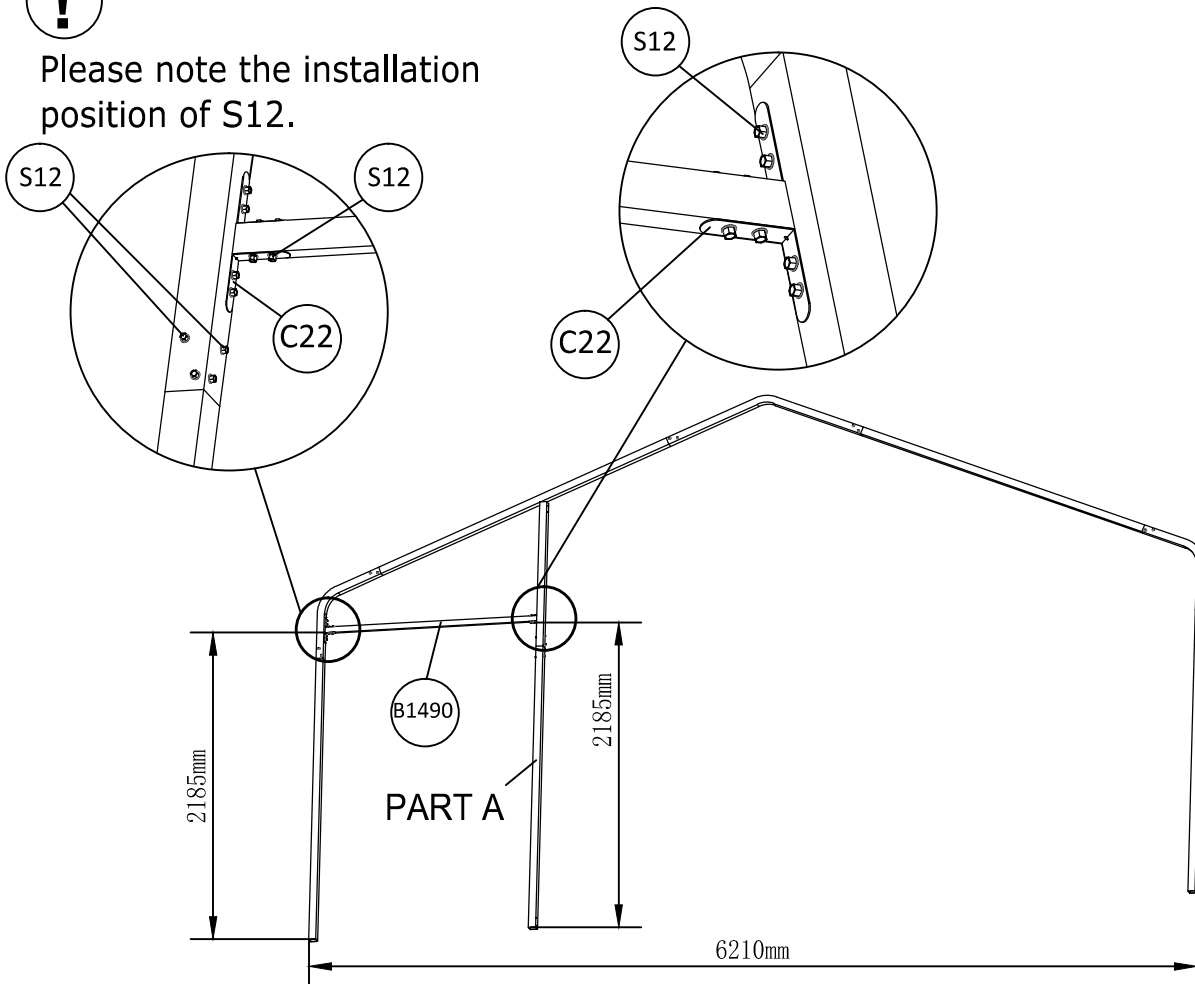

Please note the installation position of S12.



FRAME ASSEMBLY - BACK WALL

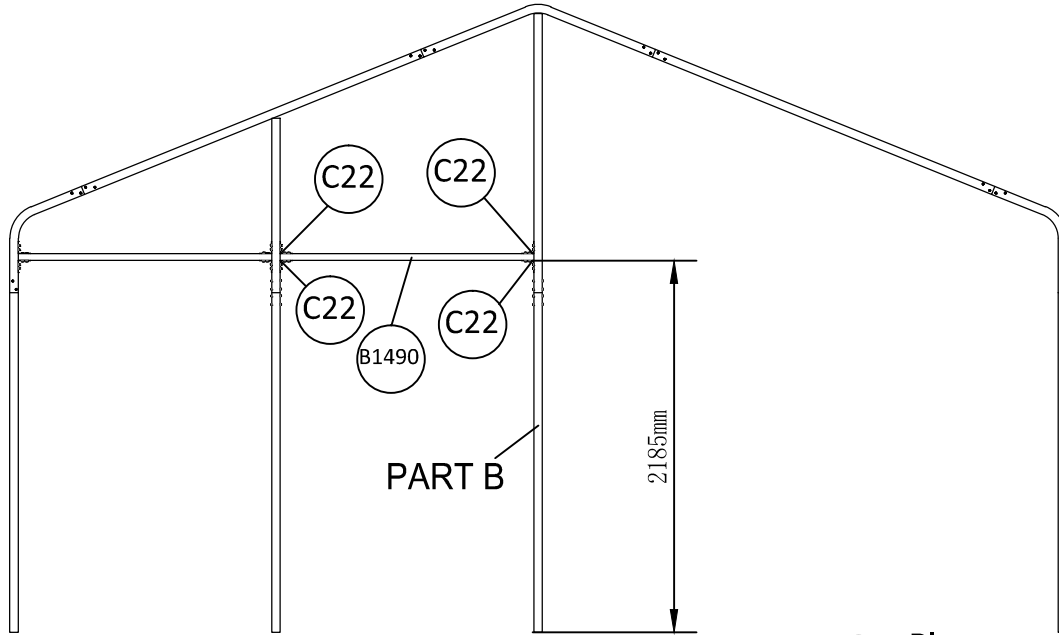

STEP 3

	B1490	1		C22	4		S12	16
---	-------	---	---	-----	---	---	-----	----



! Please note the installation position of S12.

STEP 4

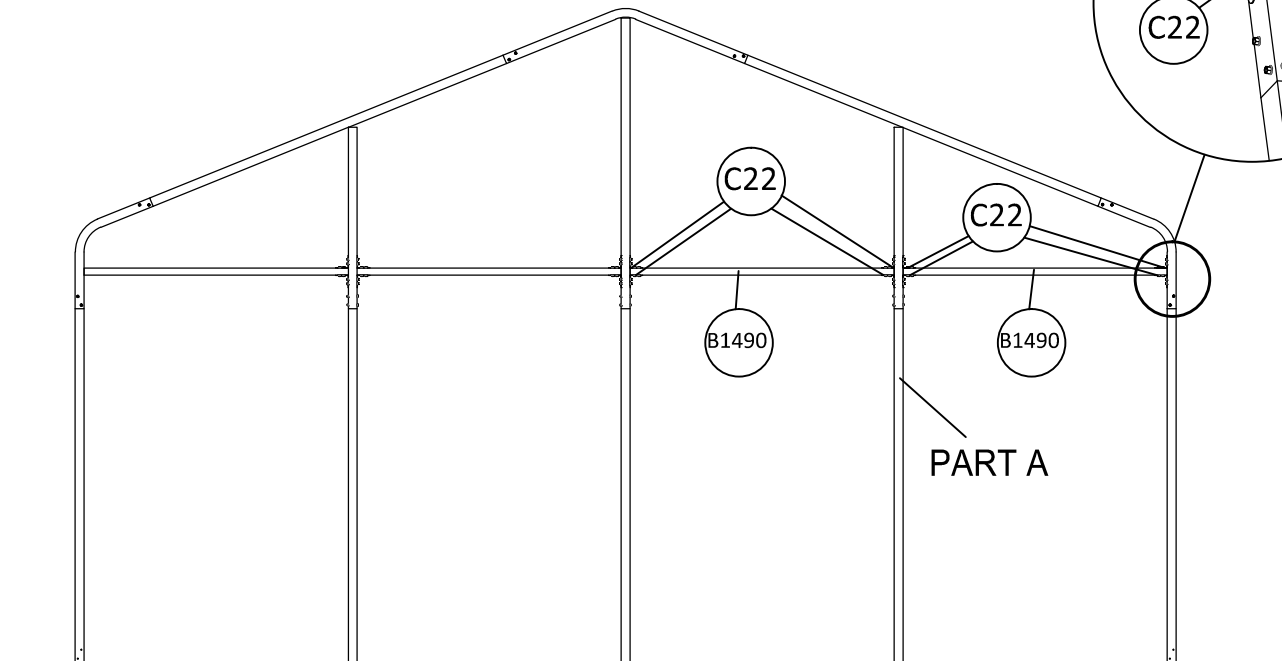

	B1490	2		C22	8		S12	32
---	-------	---	---	-----	---	---	-----	----



Make sure on the same level.

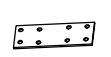

FRAME ASSEMBLY - BACK WALL

STEP 5

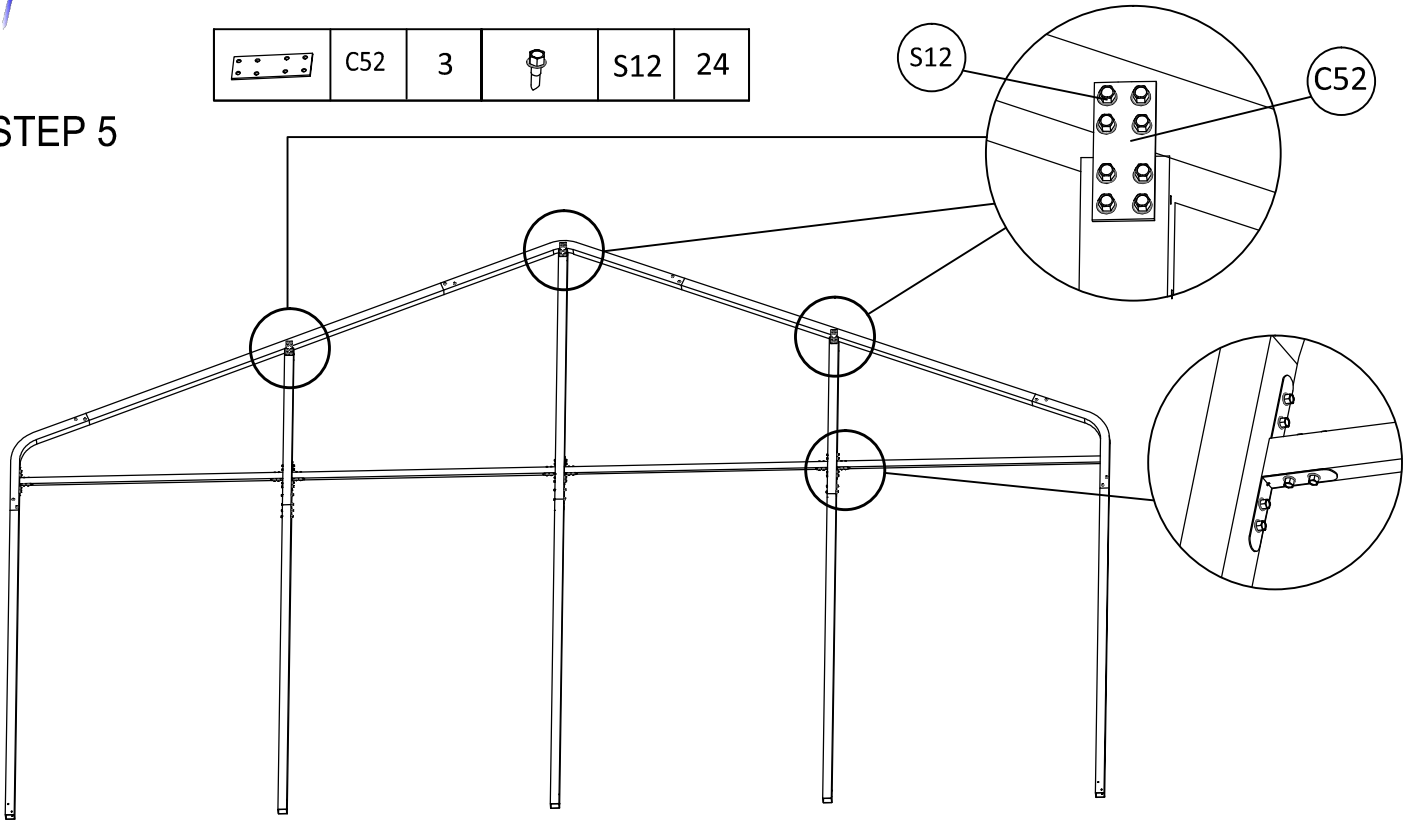
	C52	3		S12	24
---	-----	---	---	-----	----





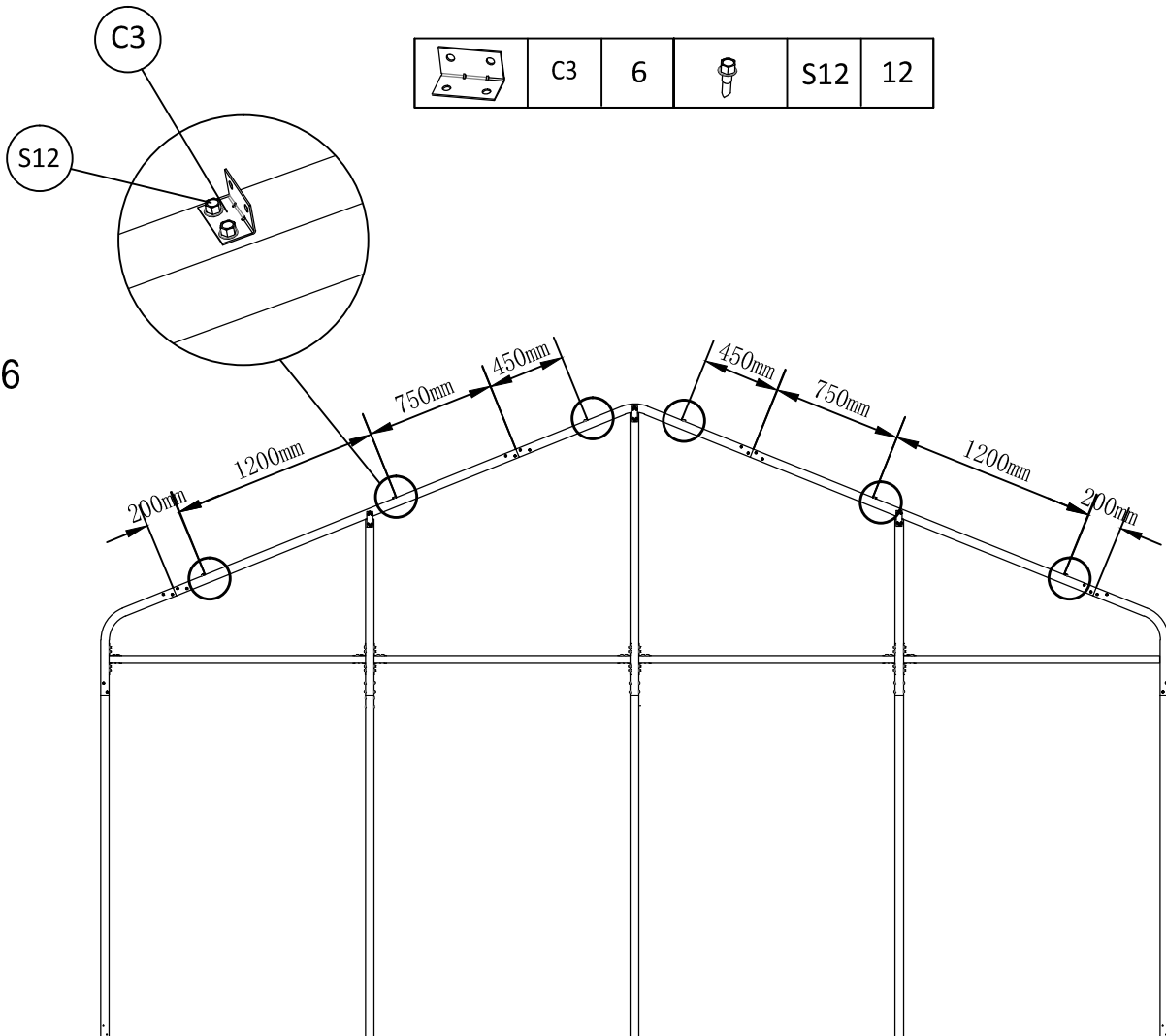

STEP 6

	C3	6		S12	12
---	----	---	---	-----	----



FRAME ASSEMBLY - FRONT WALL

STEP 1

	A1895	2		AS2	2		AS3	2		AS4	1
	S12	24									

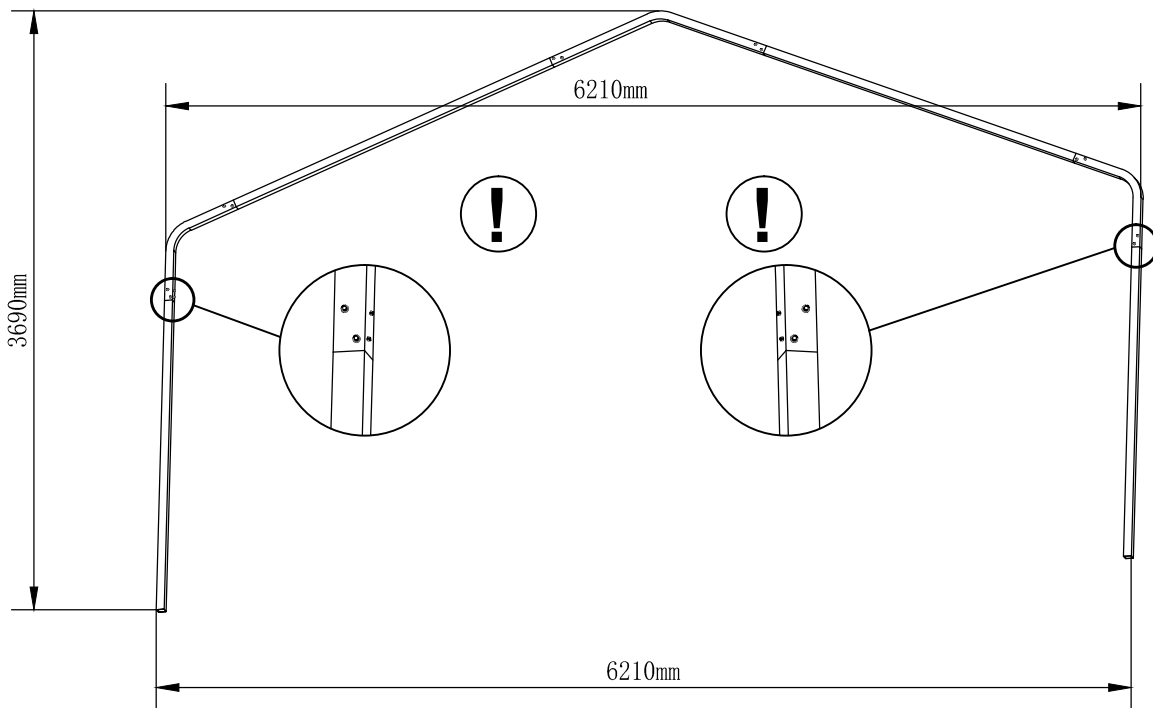
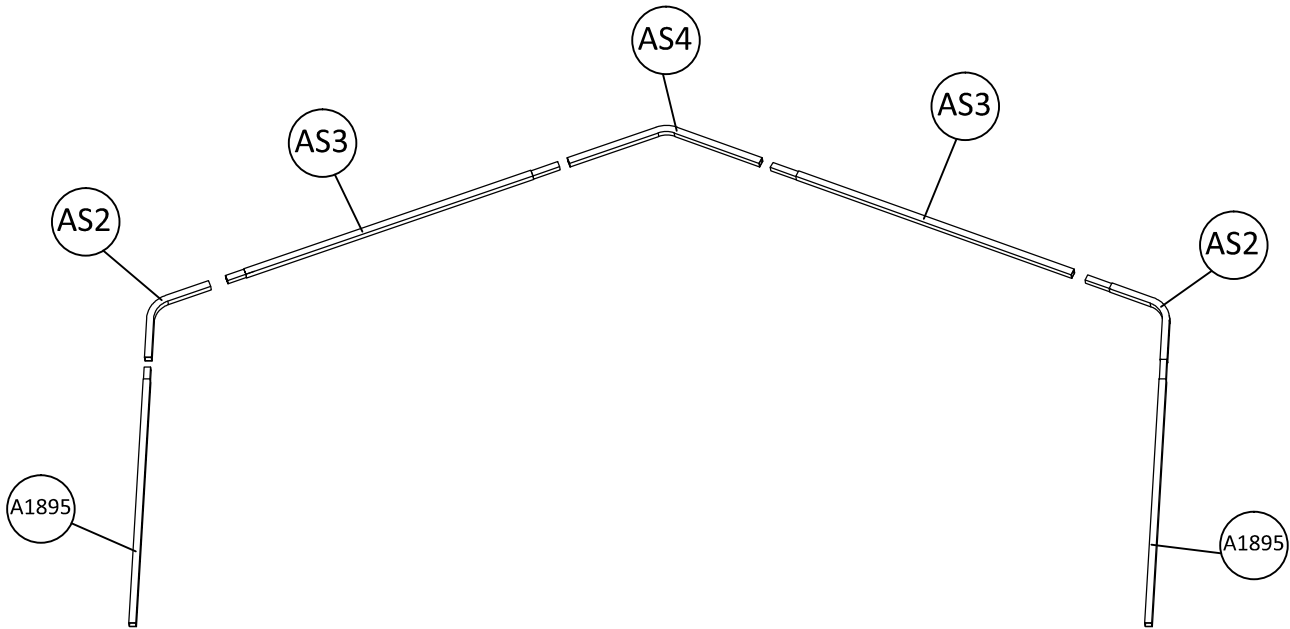

FRAME ASSEMBLY - FRONT WALL



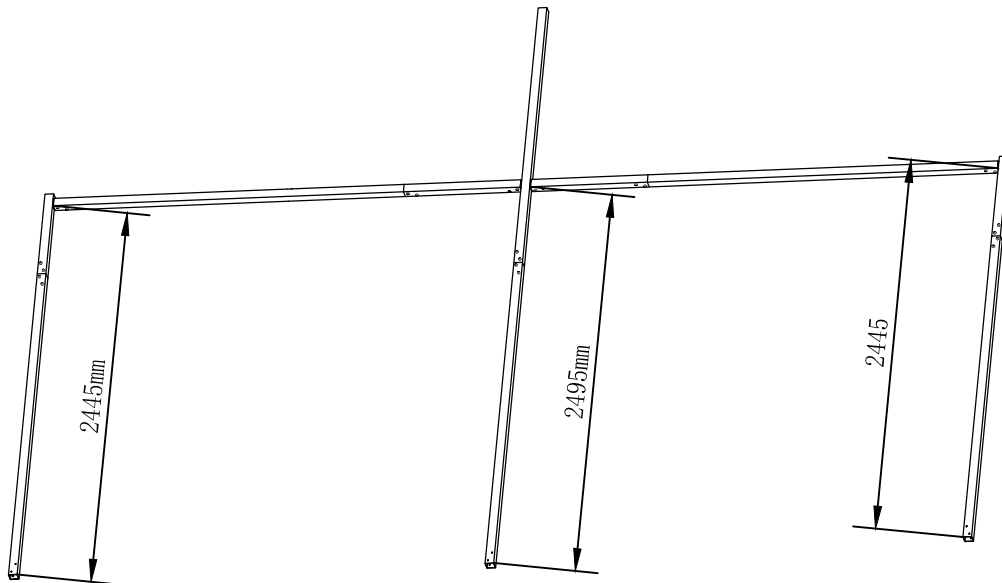
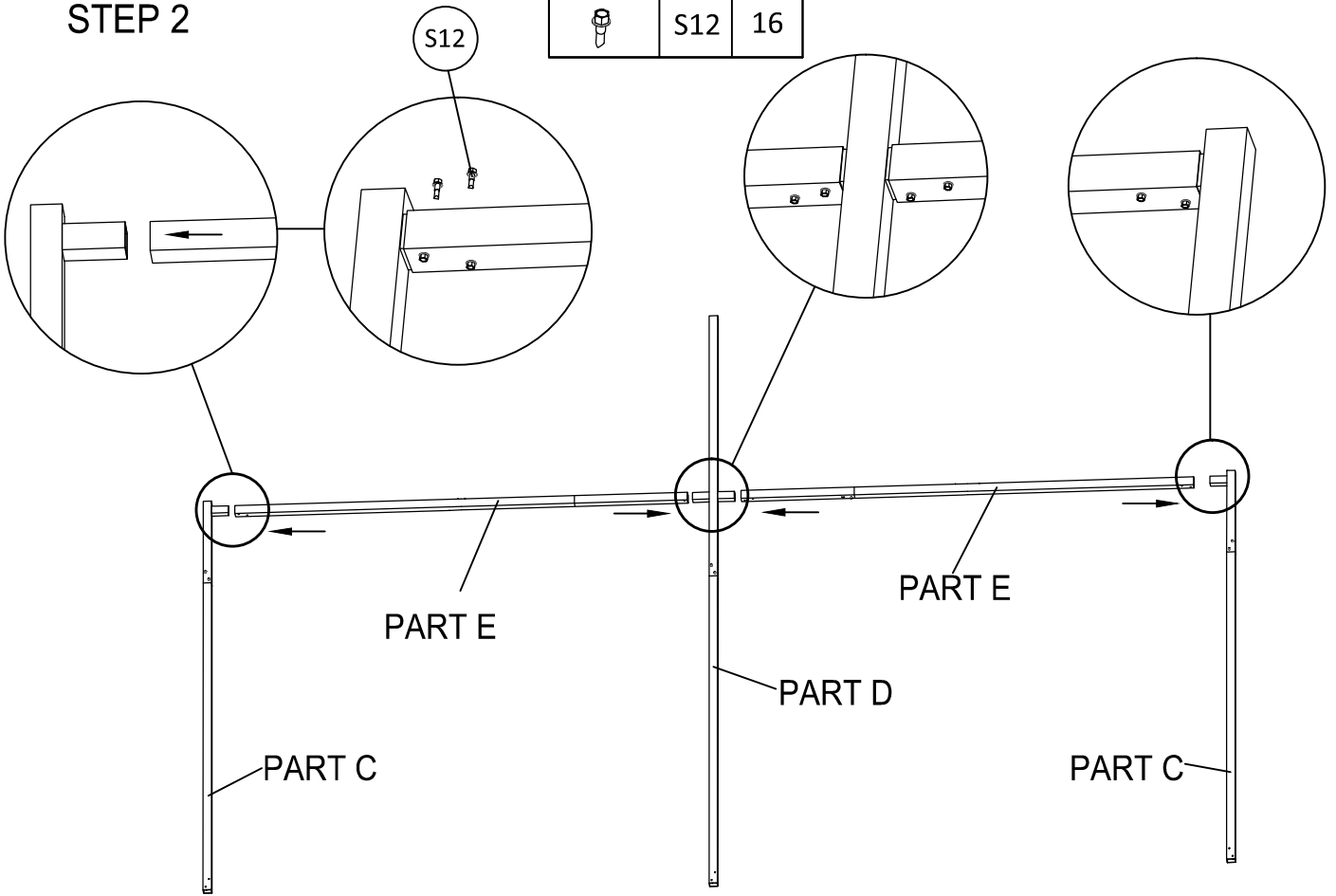

STEP 2

	S12	16
---	-----	----





FRAME ASSEMBLY - FRONT WALL

STEP 3

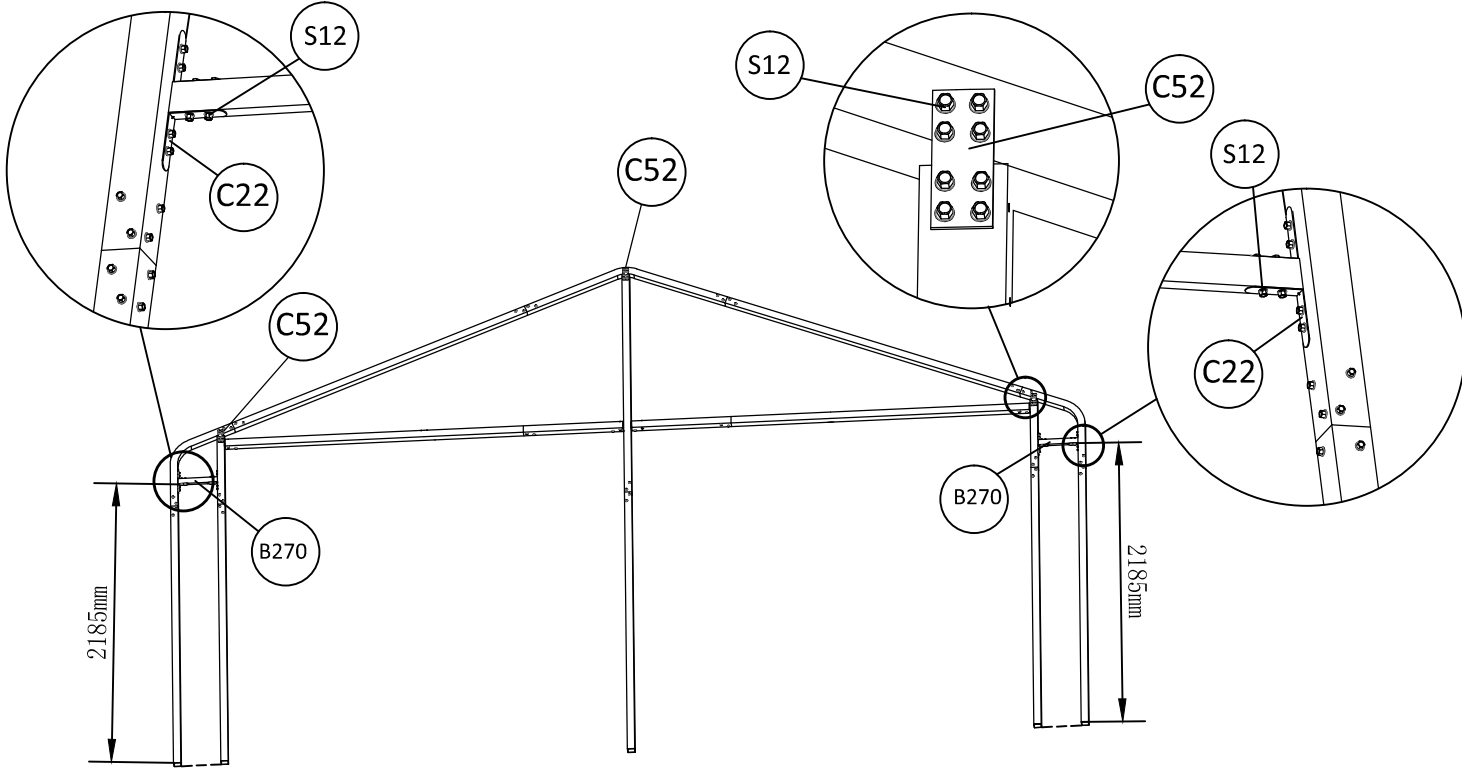
	B270	2		C22	8		C52	3		S12	56
---	------	---	---	-----	---	---	-----	---	---	-----	----





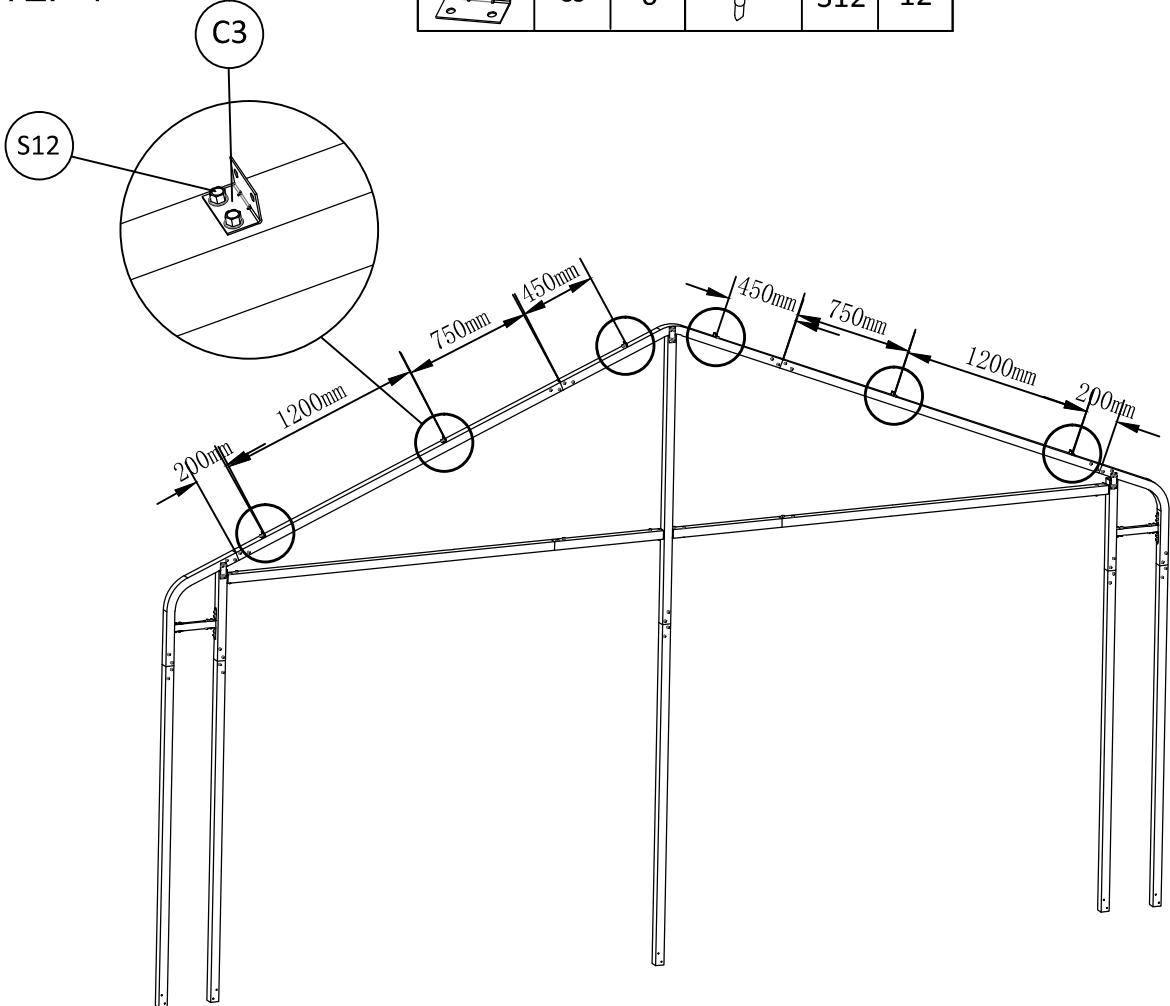

STEP 4

	C3	6		S12	12
---	----	---	---	-----	----



FRAME ASSEMBLY - MIDDLE PART

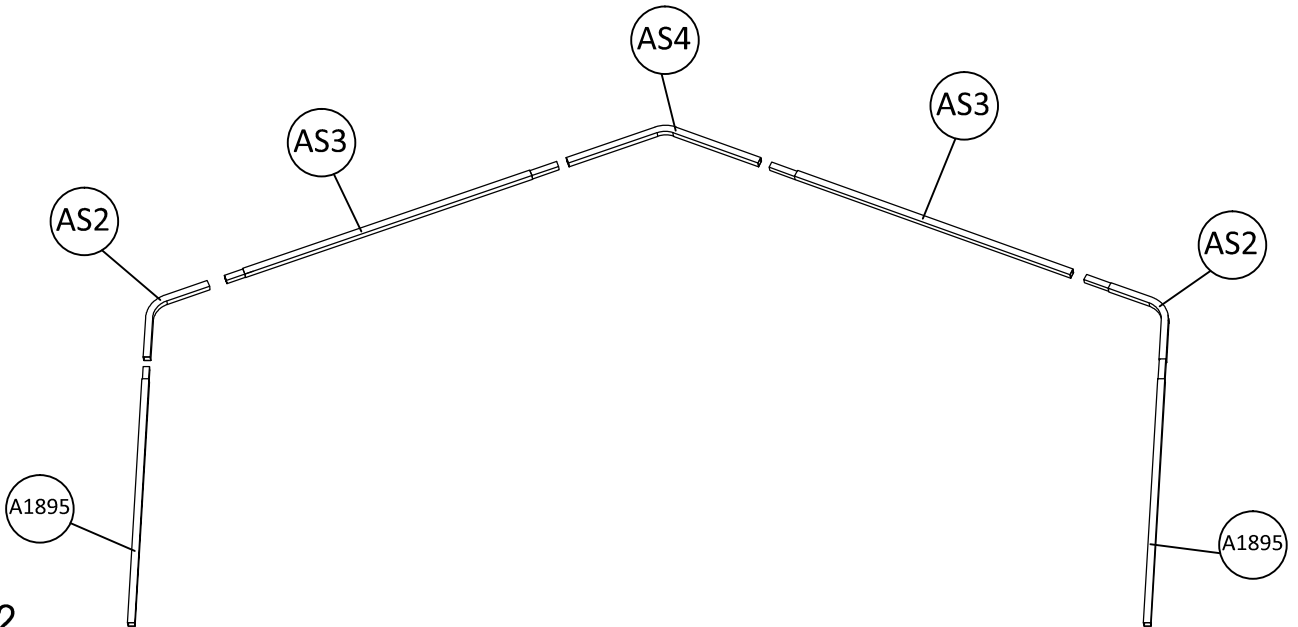

STEP 1

	A1895	2		AS2	2		AS3	2		AS4	1
	S12	24									

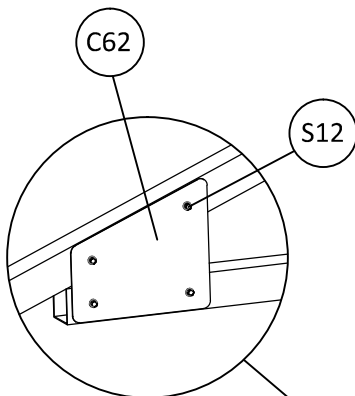

STEP 2



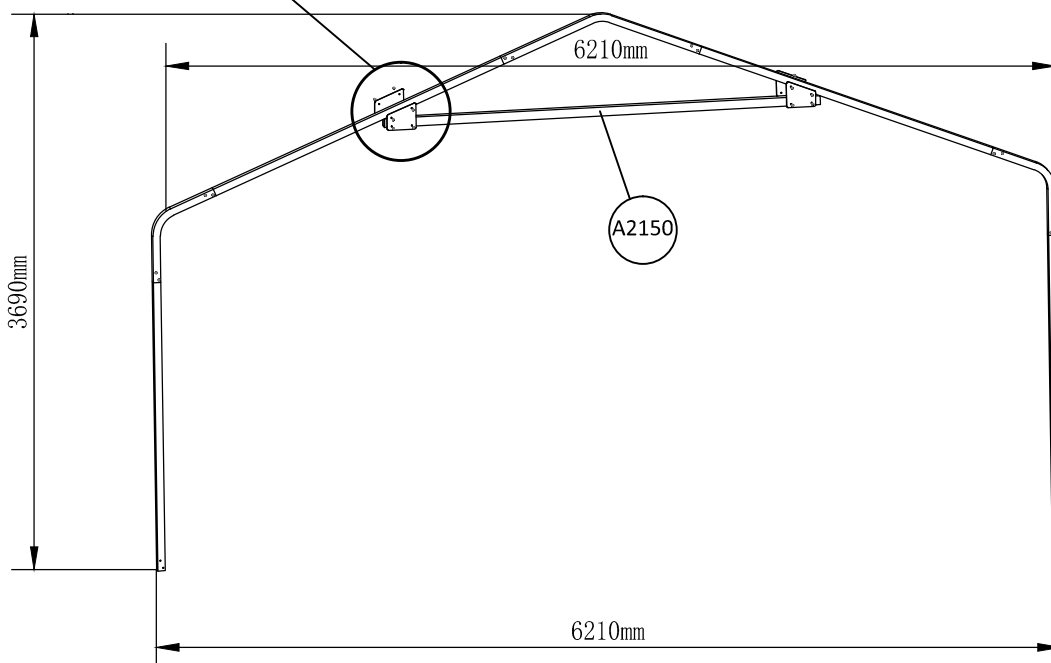

	C62	4		S12	16		A2150	1
---	-----	---	---	-----	----	---	-------	---



FRAME ASSEMBLY - MIDDLE PART





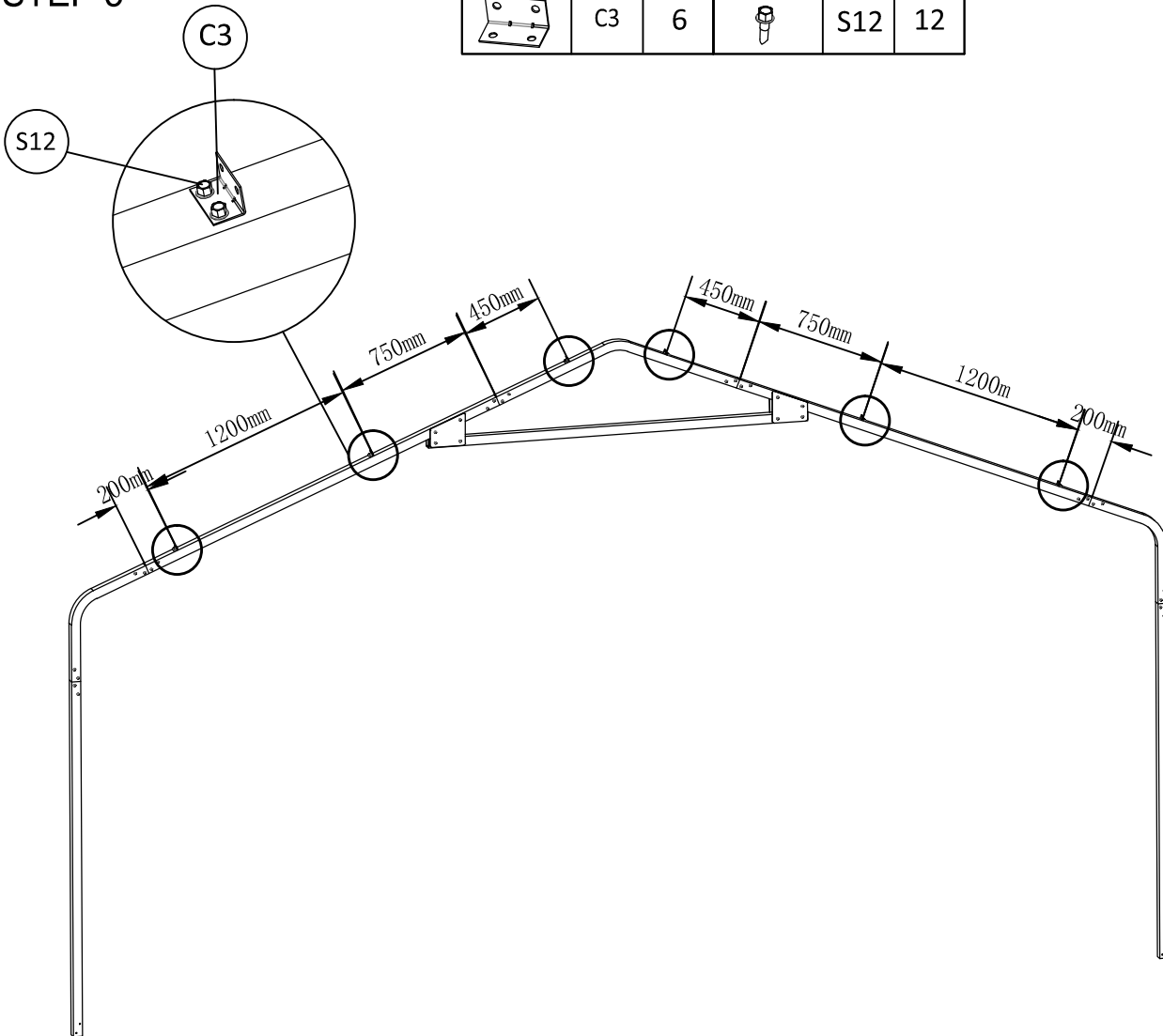

STEP 3

	C3	6		S12	12
---	----	---	---	-----	----



× 3

FRAME ASSEMBLY - BASE

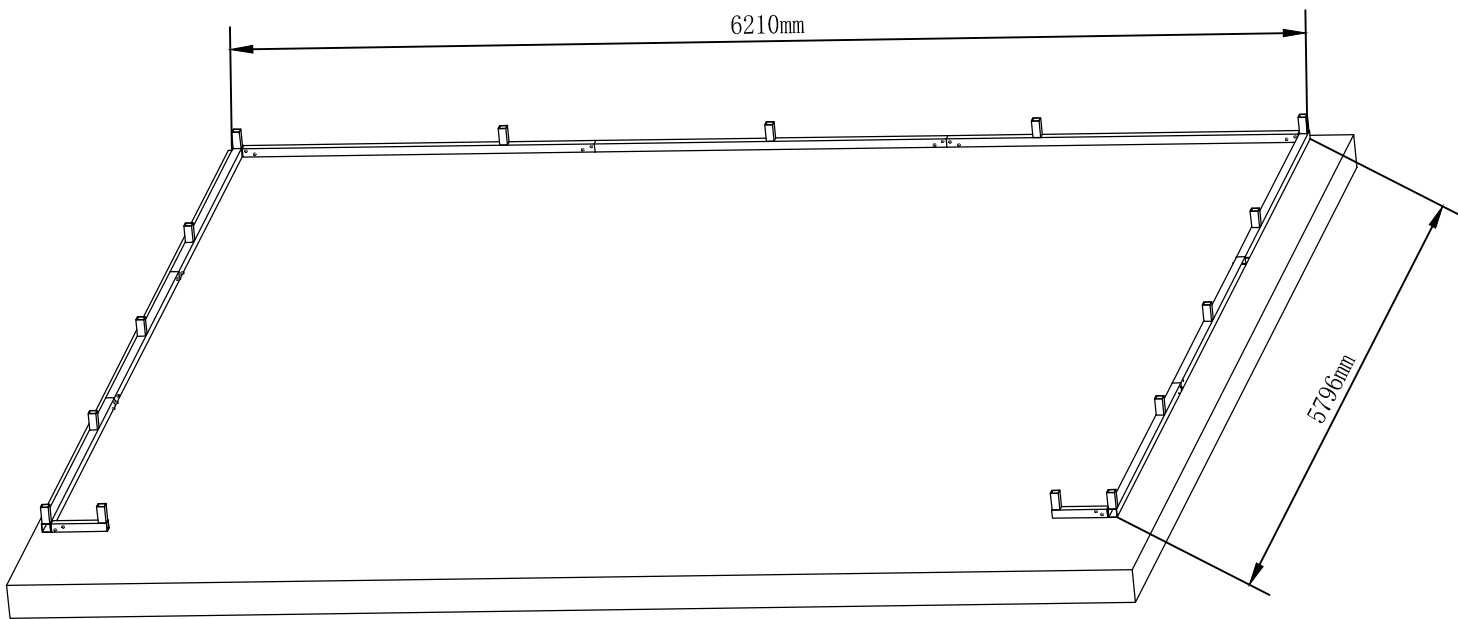
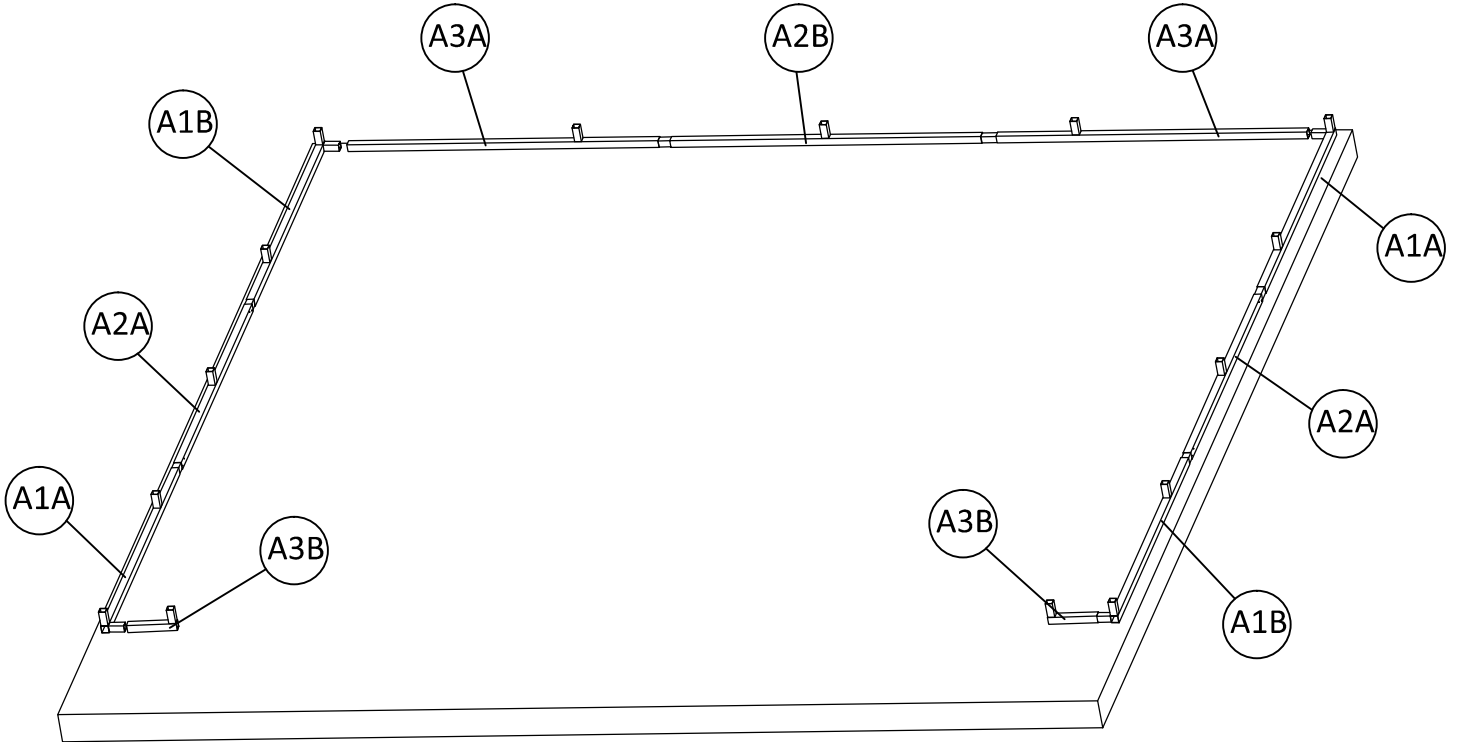

	A1B	2		A2A	2		A1A	2		A3A	2
	A2B	1		A3B	2		S12	40			

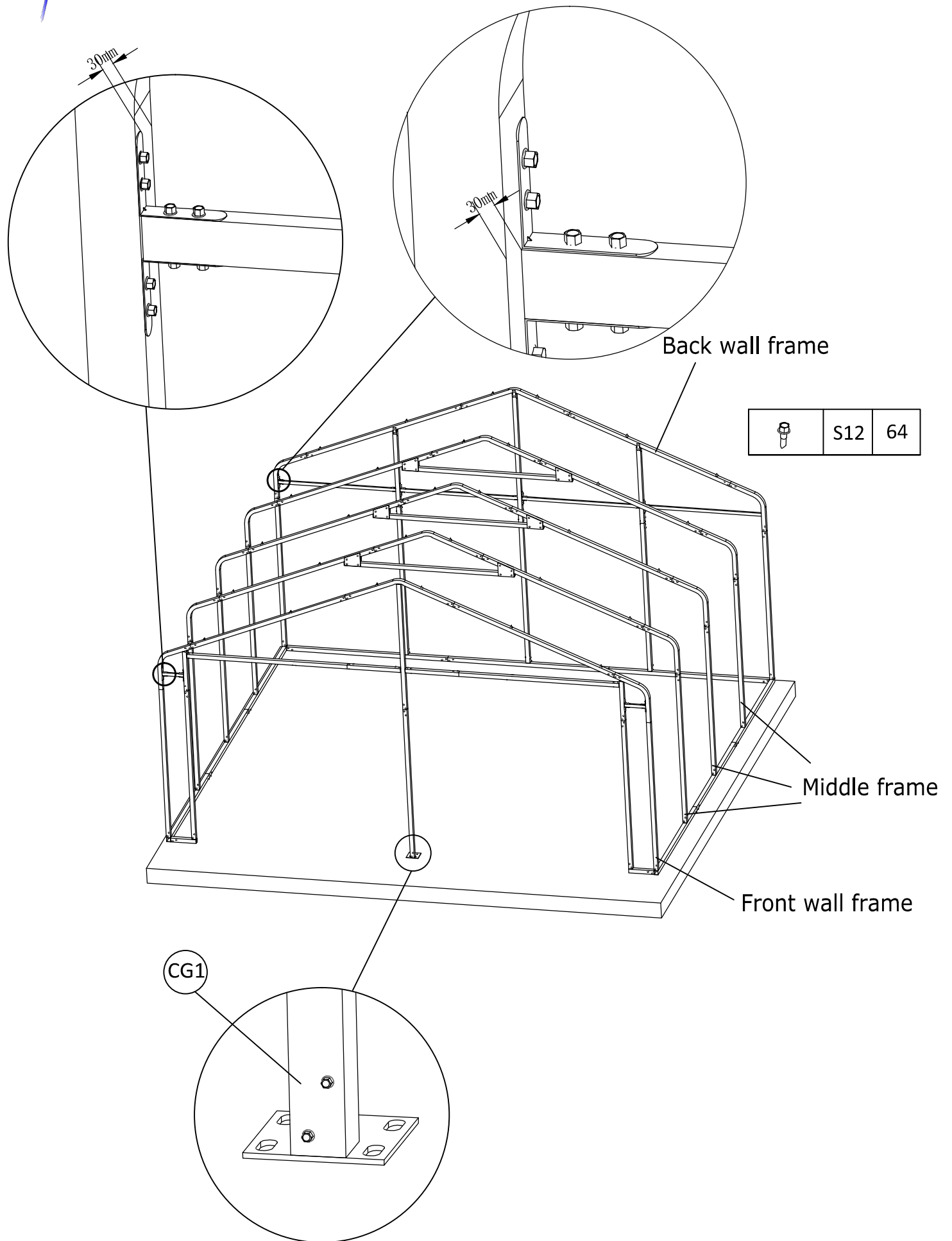

FRAME ASSEMBLY





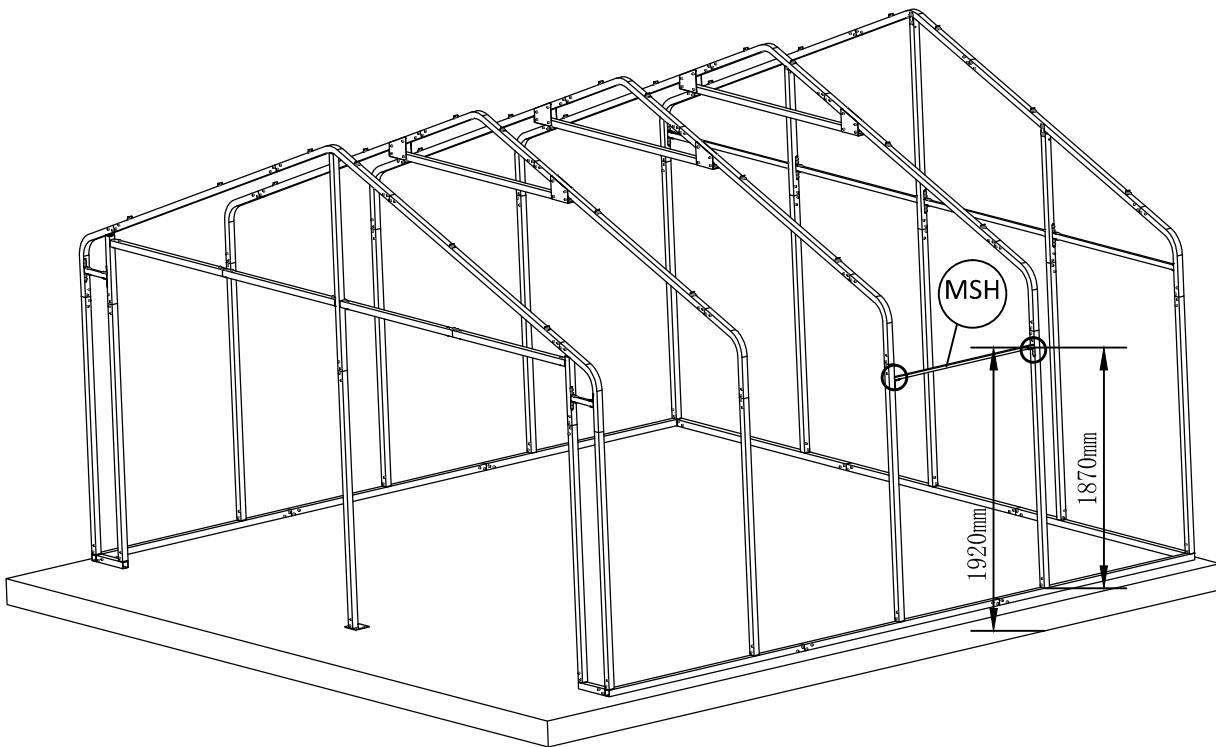
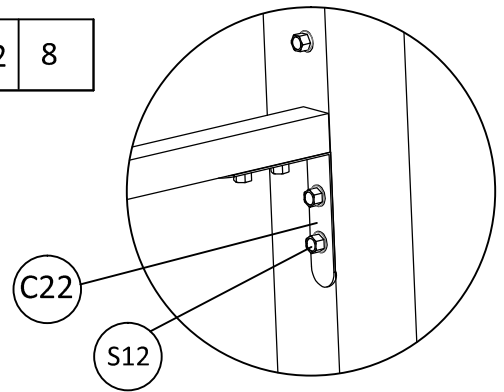

FRAME ASSEMBLY

	MSH	1		C22	2		S12	8
---	-----	---	---	-----	---	---	-----	---



FRAME ASSEMBLY - BEAM PART

	B1467	12		B1432	12		S12	60		S13	48
---	-------	----	---	-------	----	---	-----	----	---	-----	----

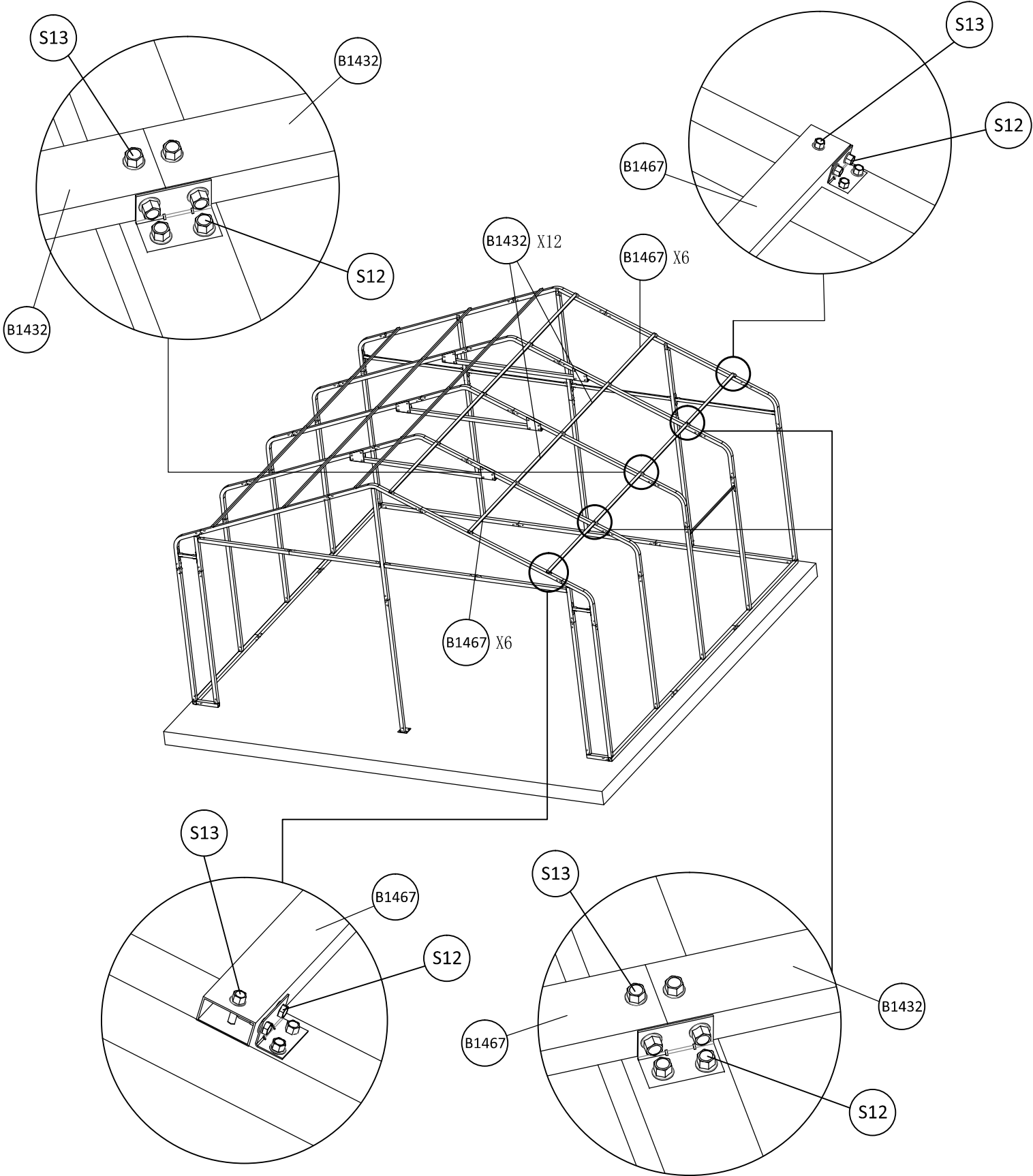

FRAME ASSEMBLY

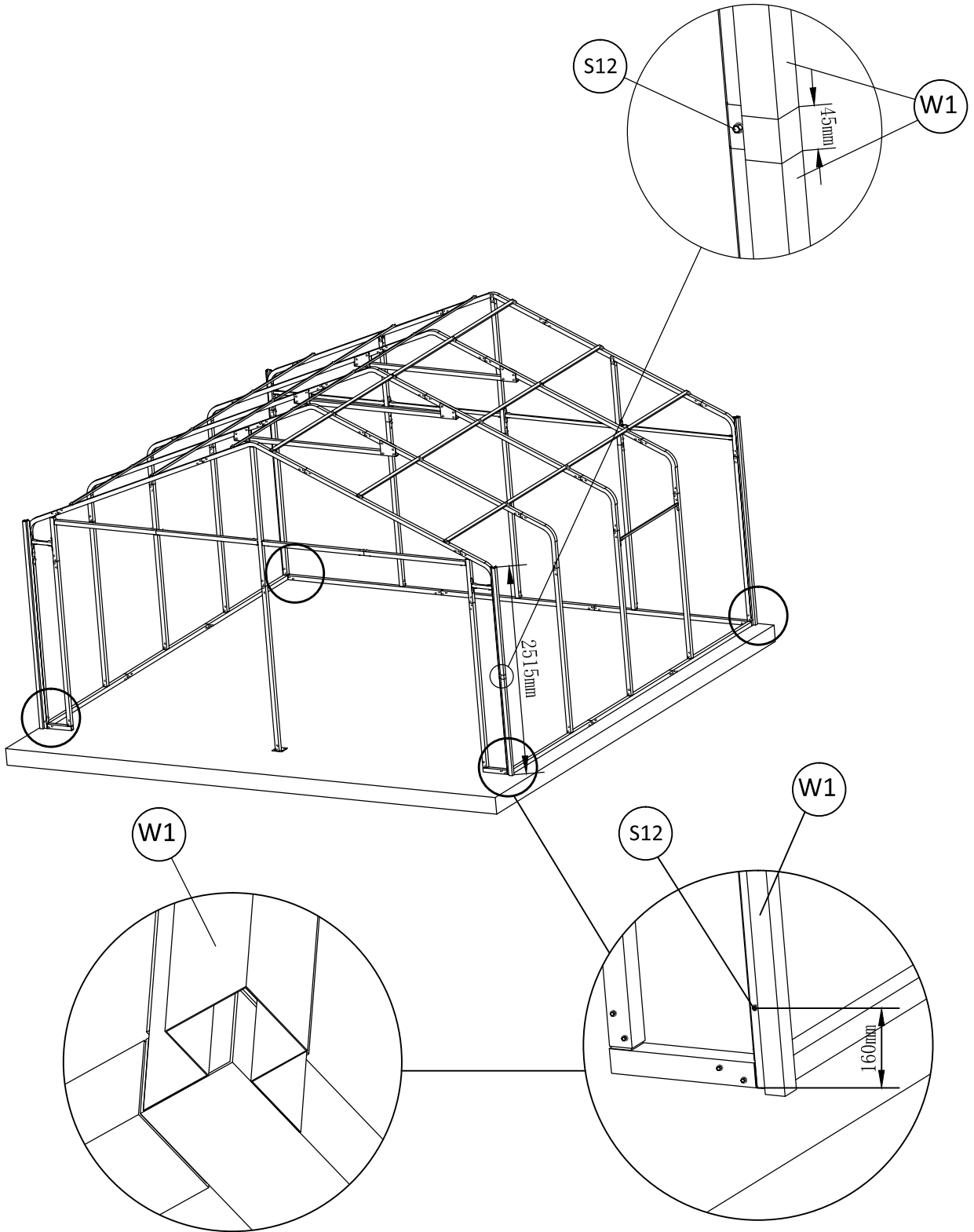

	W1	8		S12	16
---	----	---	---	-----	----



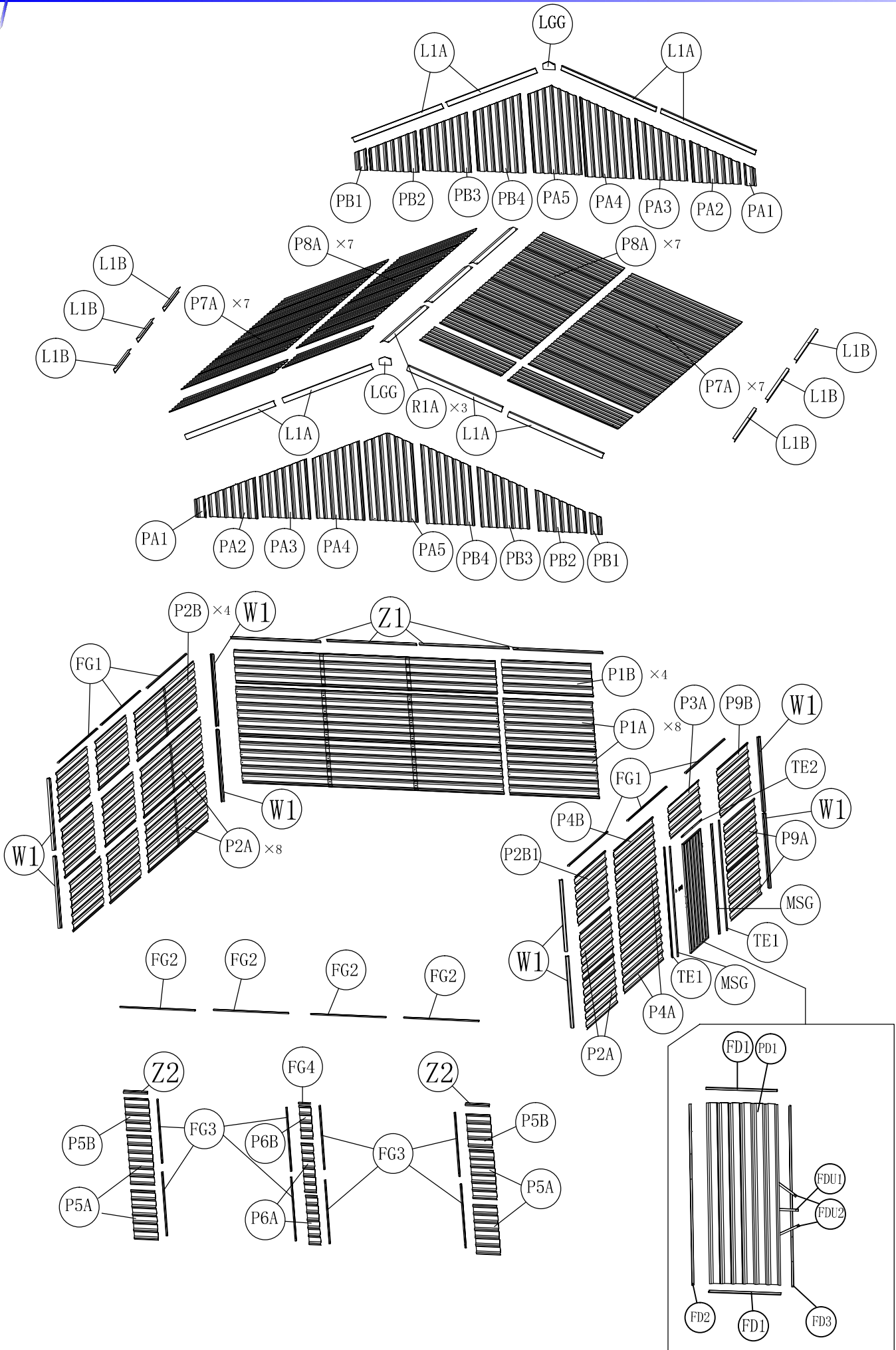

PANEL ASSEMBLY



PANEL ASSEMBLY - BACK WALL

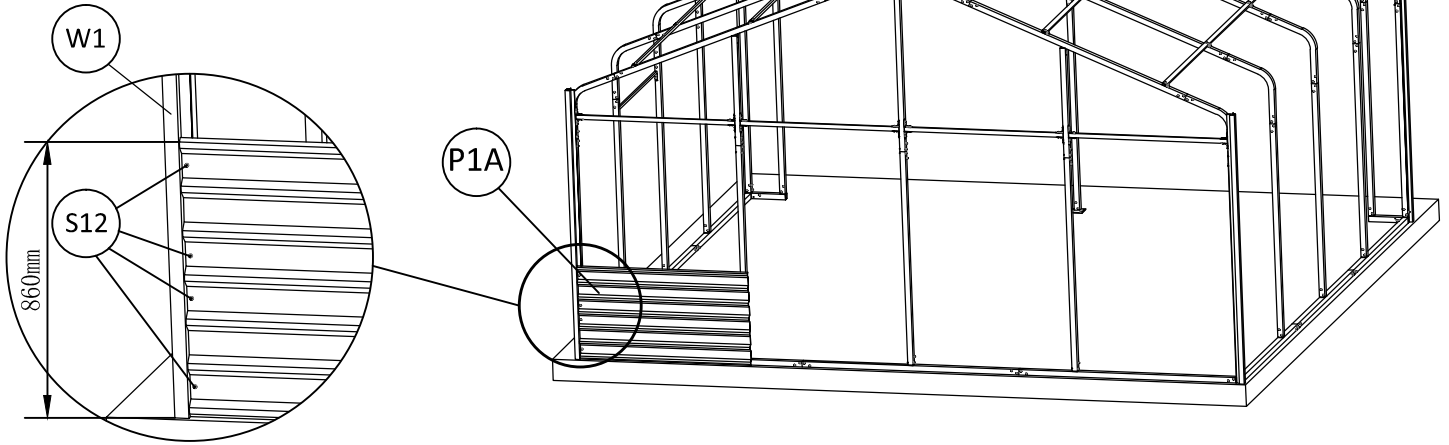

	P1A	1		S12	4
---	-----	---	---	-----	---

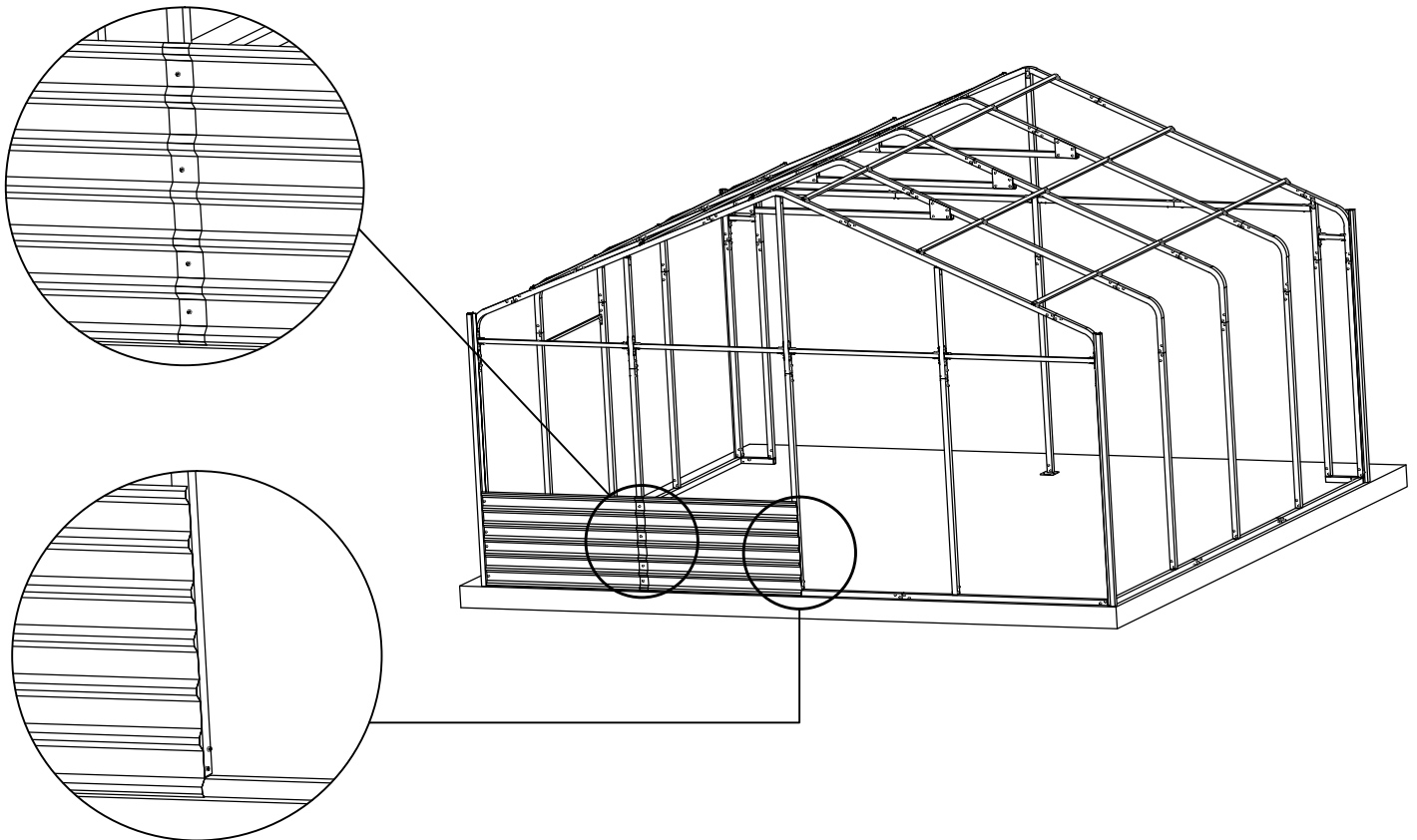

	P1A	1		S12	4
--	-----	---	--	-----	---





PANEL ASSEMBLY - BACK WALL

	P1A	2		S12	12
---	-----	---	---	-----	----

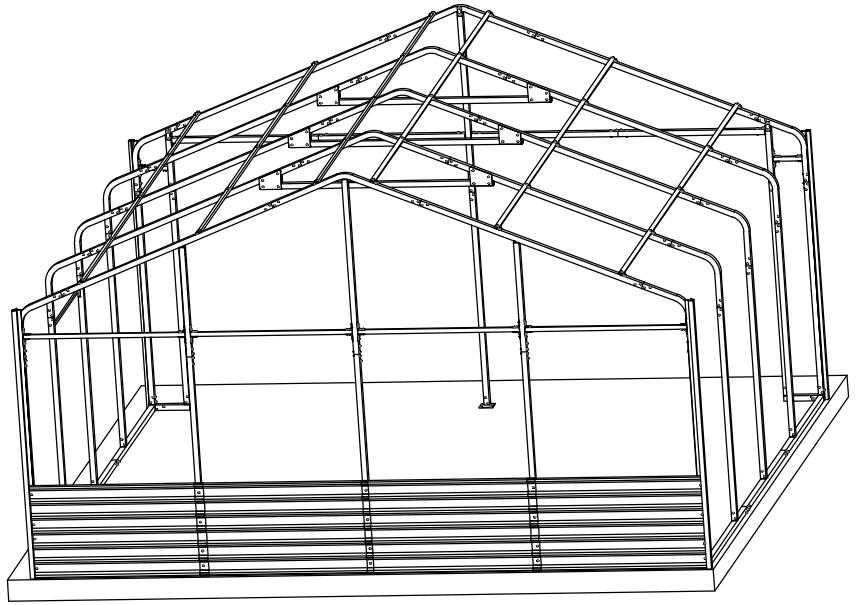
If installing windows, refer to pages 48 and 49.





	P1A	4		S12	20
--	-----	---	---	-----	----

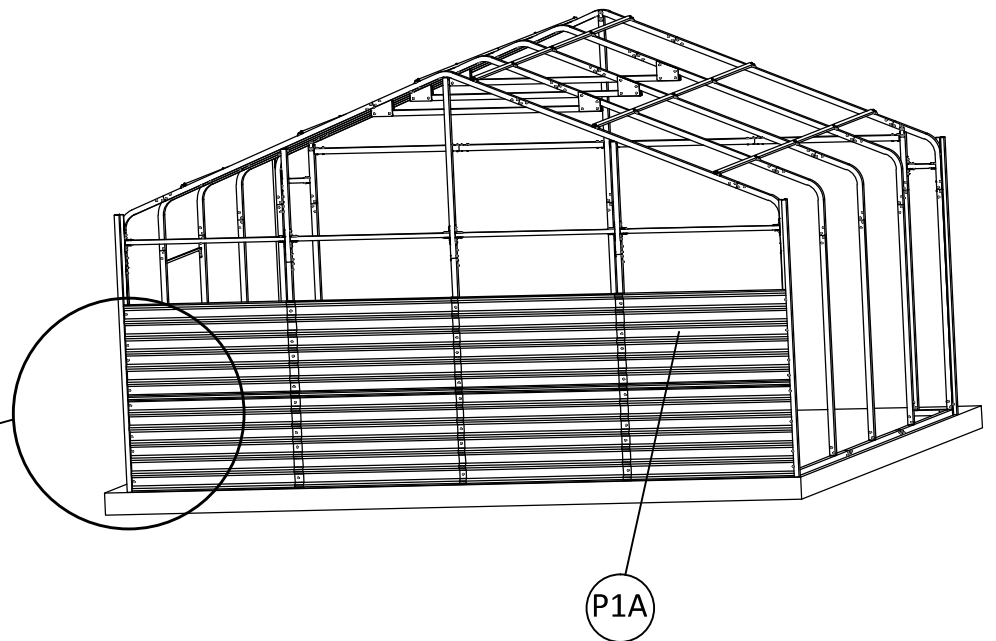
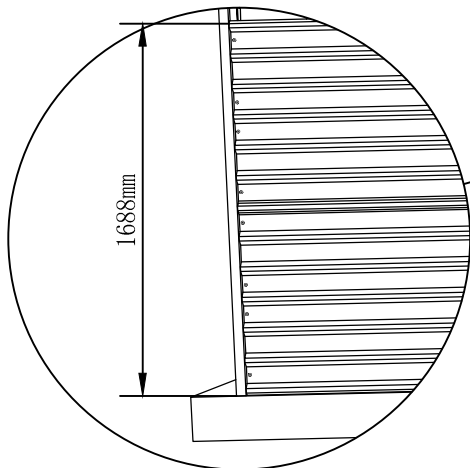
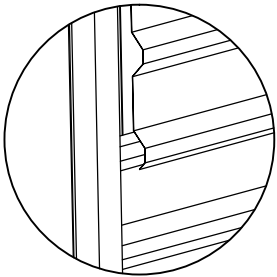

When two panels overlap, make sure upper panel covers the lower panel.

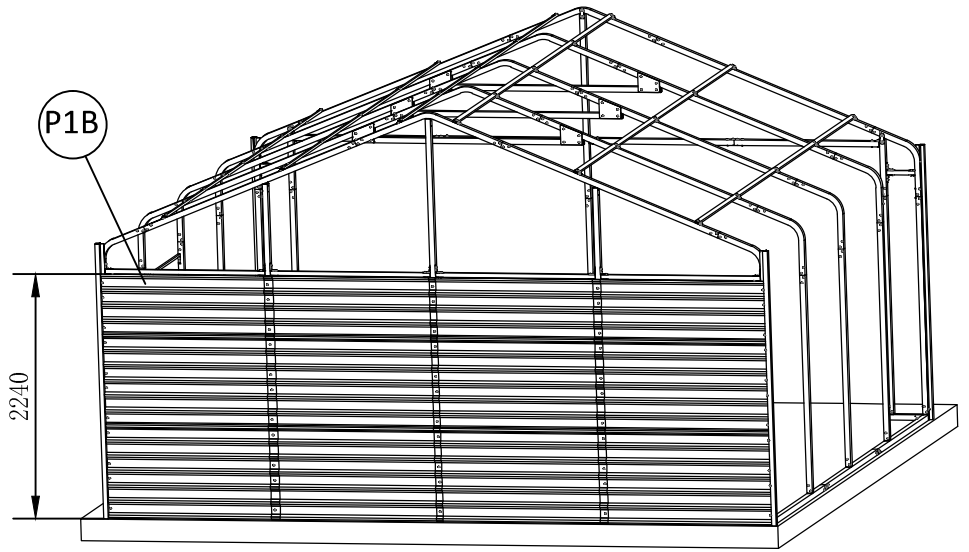
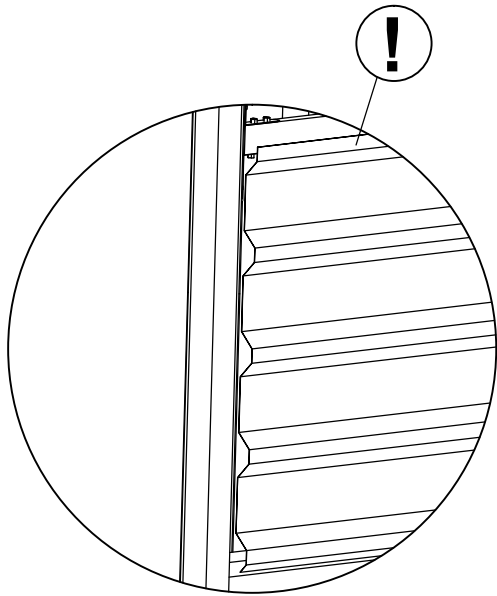

PANEL ASSEMBLY - BACK WALL

	P1B	4		S12	20
---	-----	---	---	-----	----



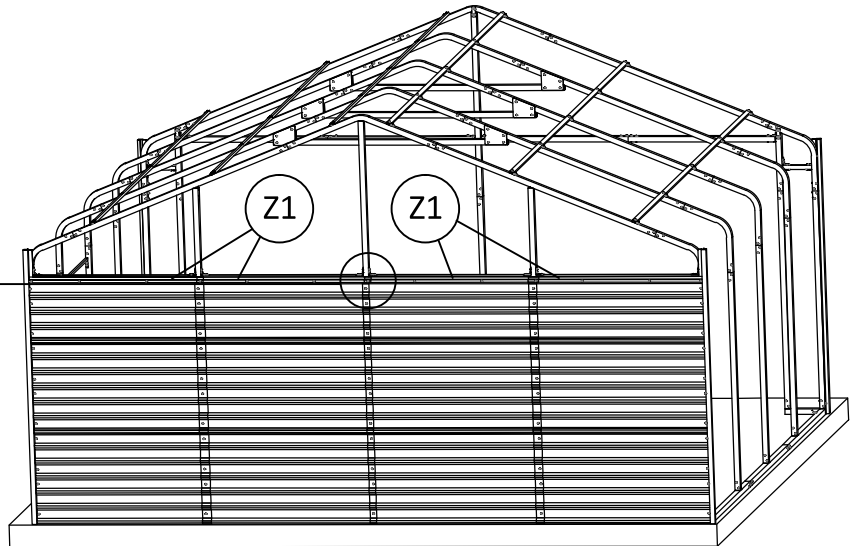
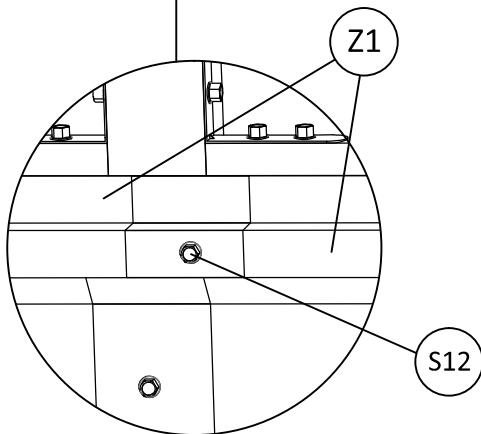
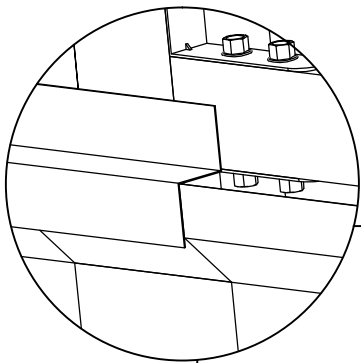

	Z1	4		S12	13
---	----	---	---	-----	----



PANEL ASSEMBLY - LEFT WALL

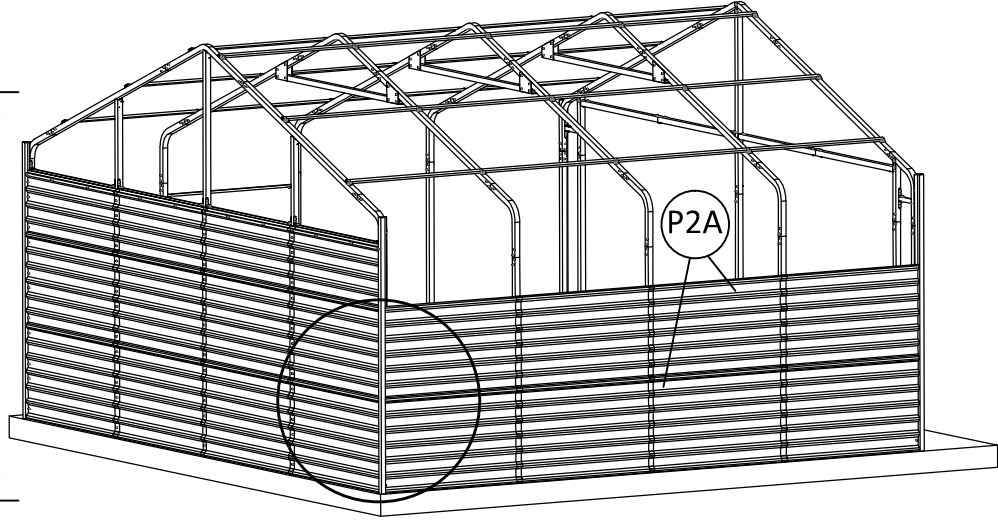
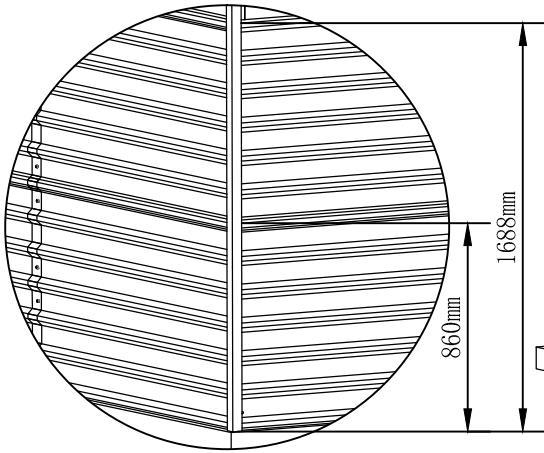

	P2A	8		S12	40
---	-----	---	---	-----	----



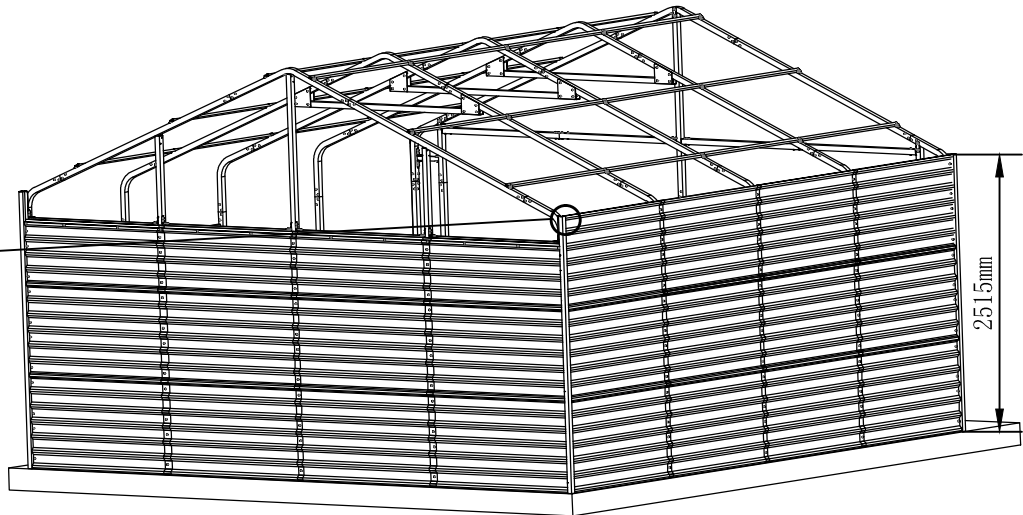
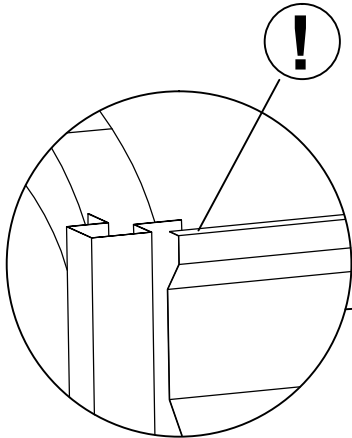



	P2B	4		S12	20
---	-----	---	---	-----	----

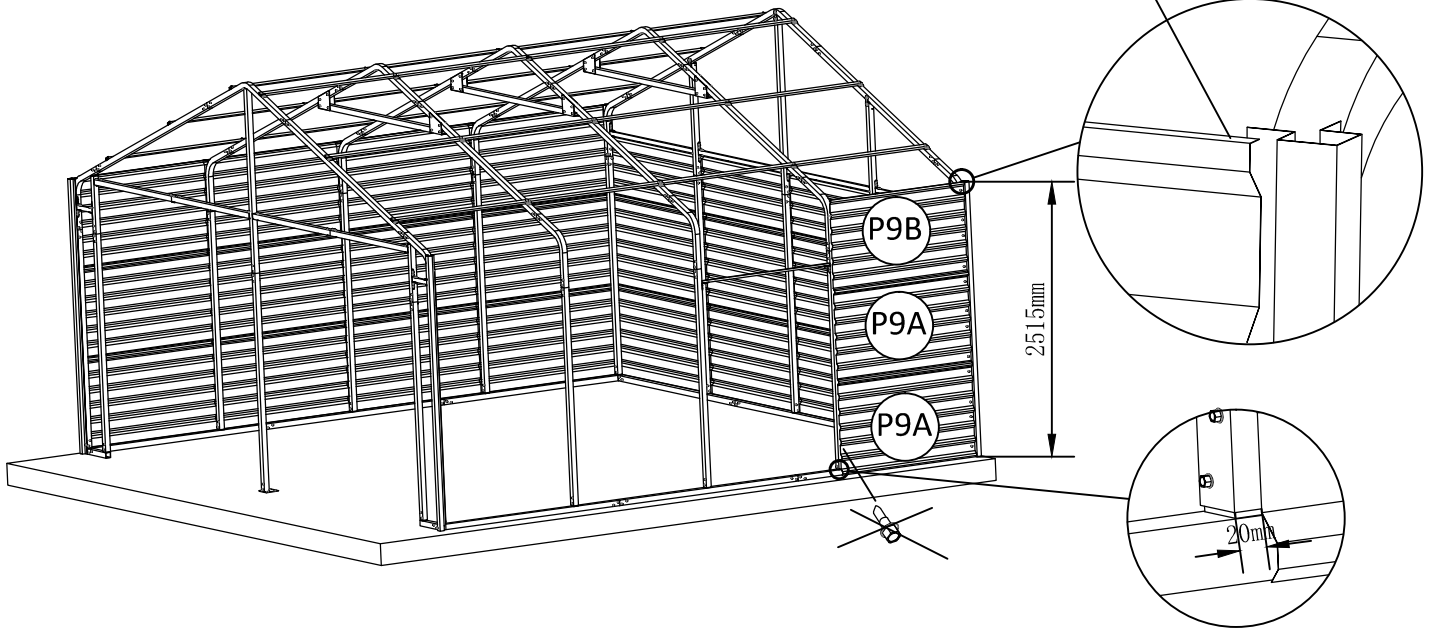

PANEL ASSEMBLY - RIGHT WALL

	P9A	2		P9B	1		S12	12
---	-----	---	---	-----	---	---	-----	----





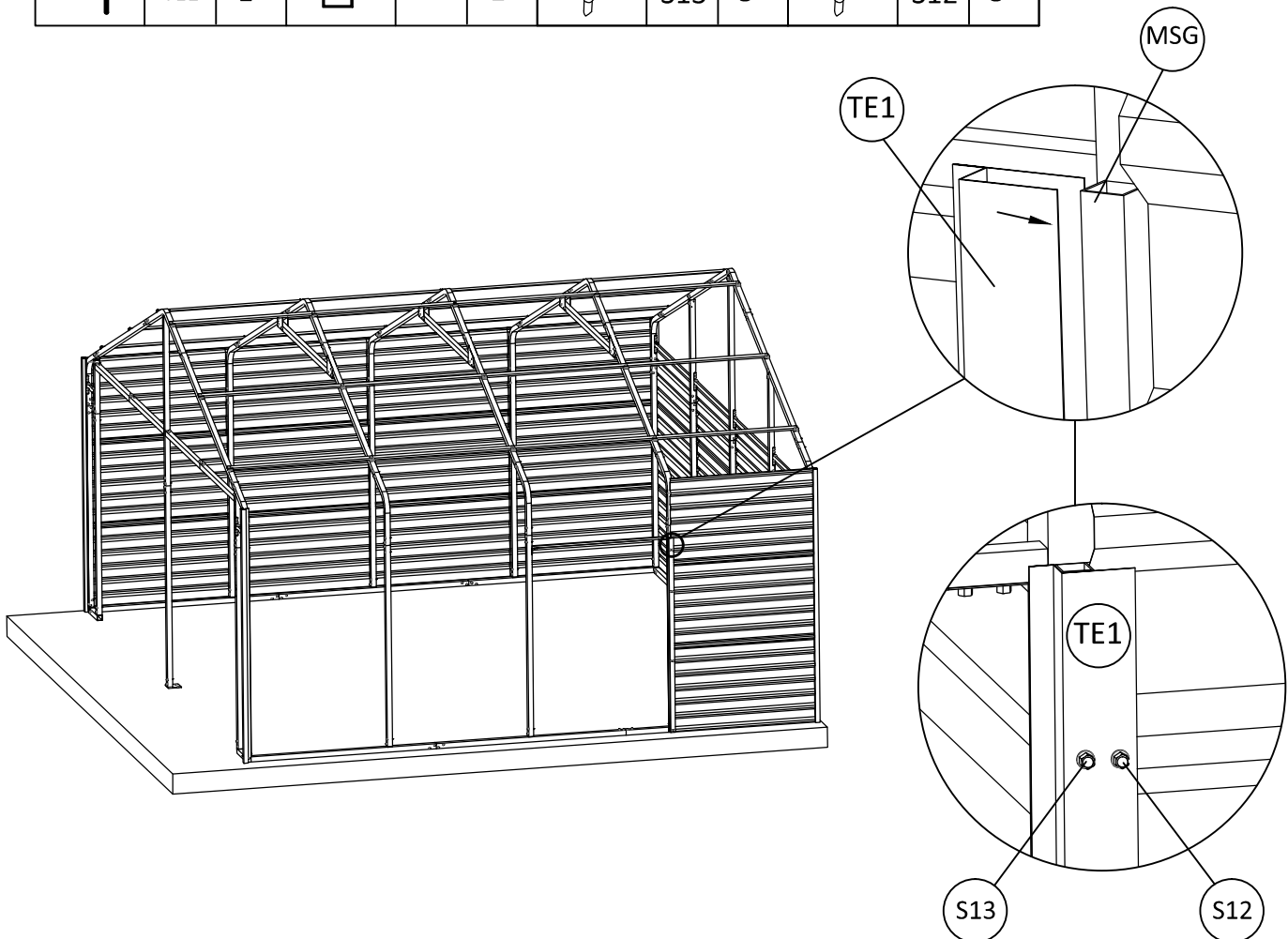

4	TE1	1		MSG	1		S13	5		S12	5
---	-----	---	---	-----	---	---	-----	---	---	-----	---

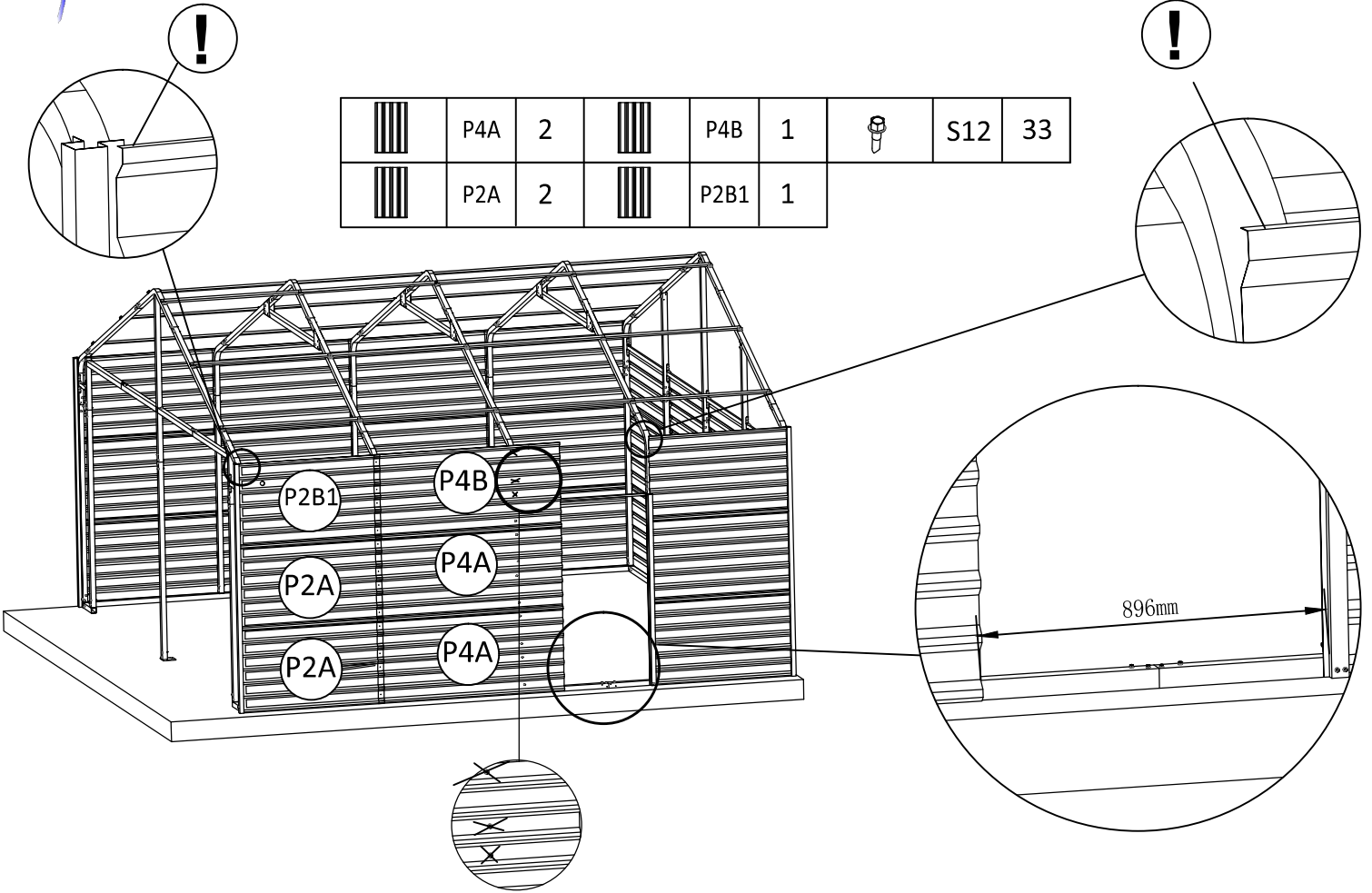

PANEL ASSEMBLY - RIGHT WALL





	P4A	2		P4B	1		S12	33
	P2A	2		P2B1	1			

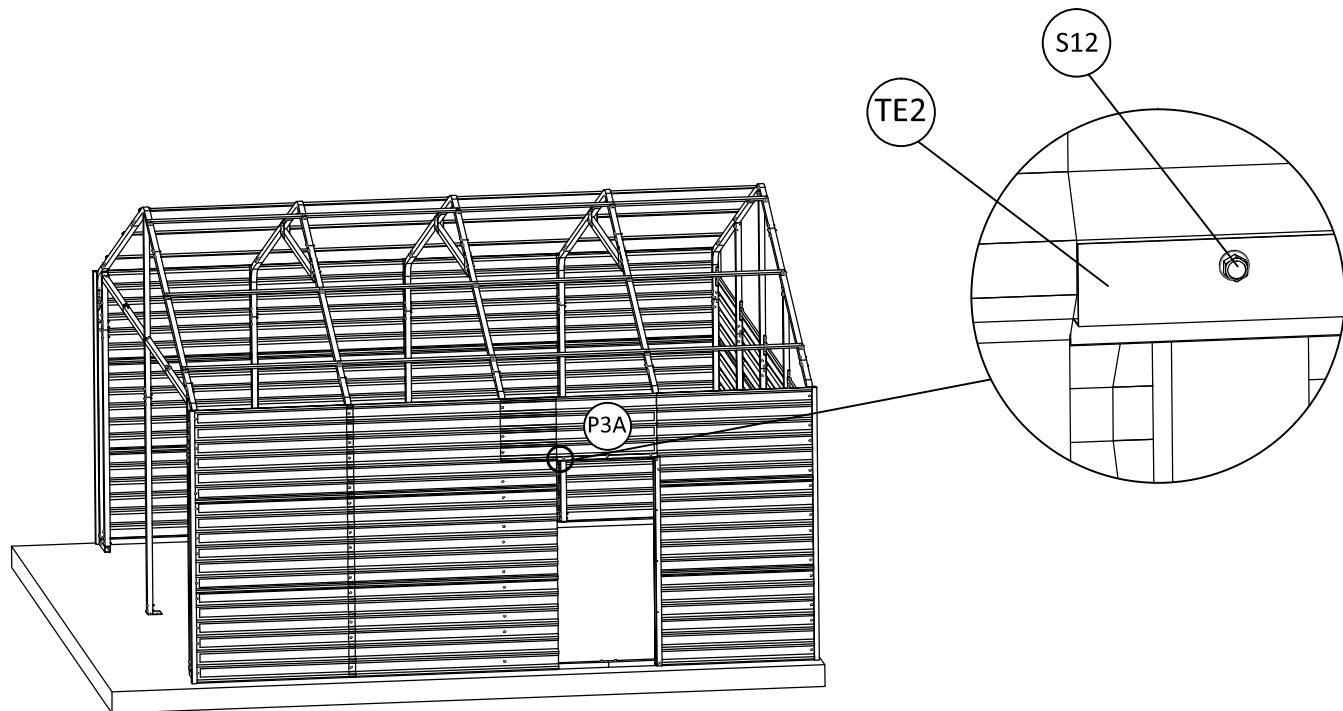

	P3A	1		S12	9		TE2	1
---	-----	---	---	-----	---	---	-----	---





PANEL ASSEMBLY - RIGHT WALL

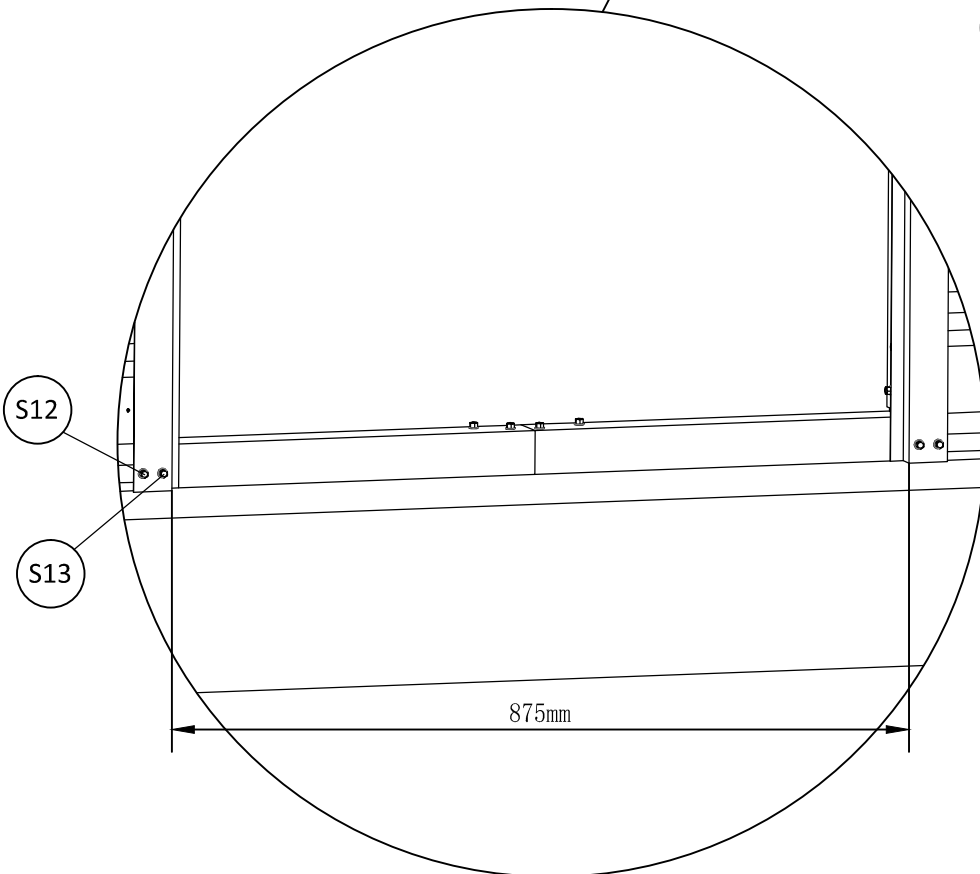
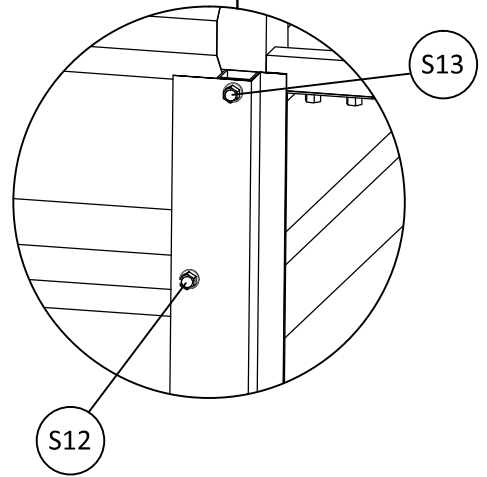
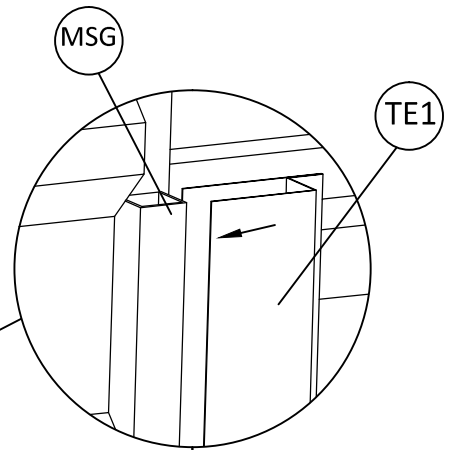
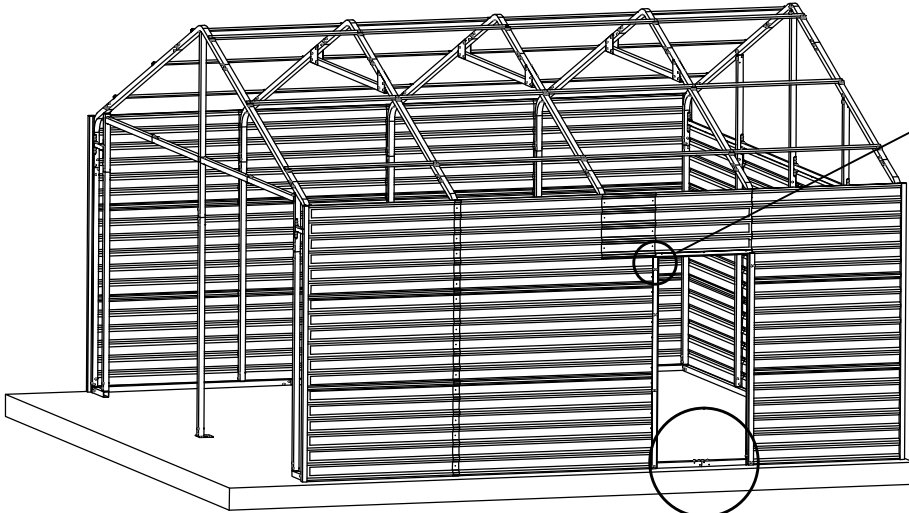





	TE1	1		S12	8		S13	2
	MSG	1						

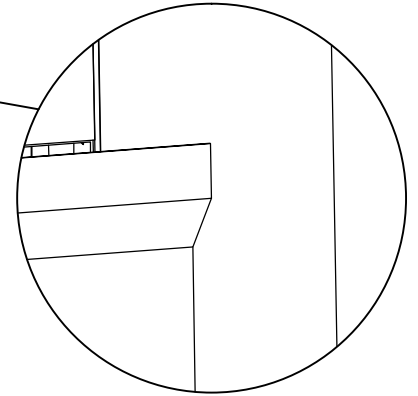
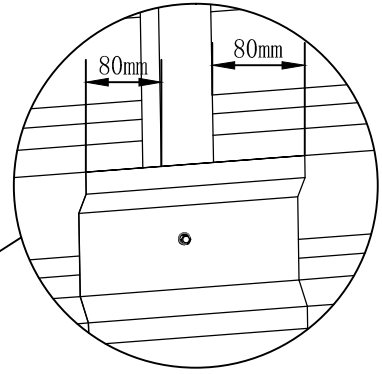
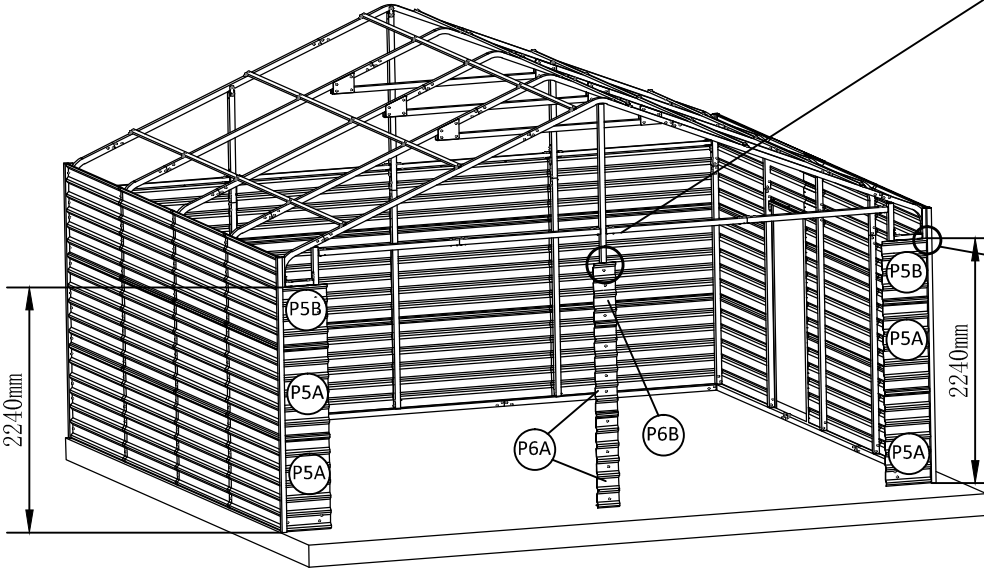

PANEL ASSEMBLY - FRONT WALL

	P5A	4		P5B	2		S12	51
	P6A	2		P6B	1			



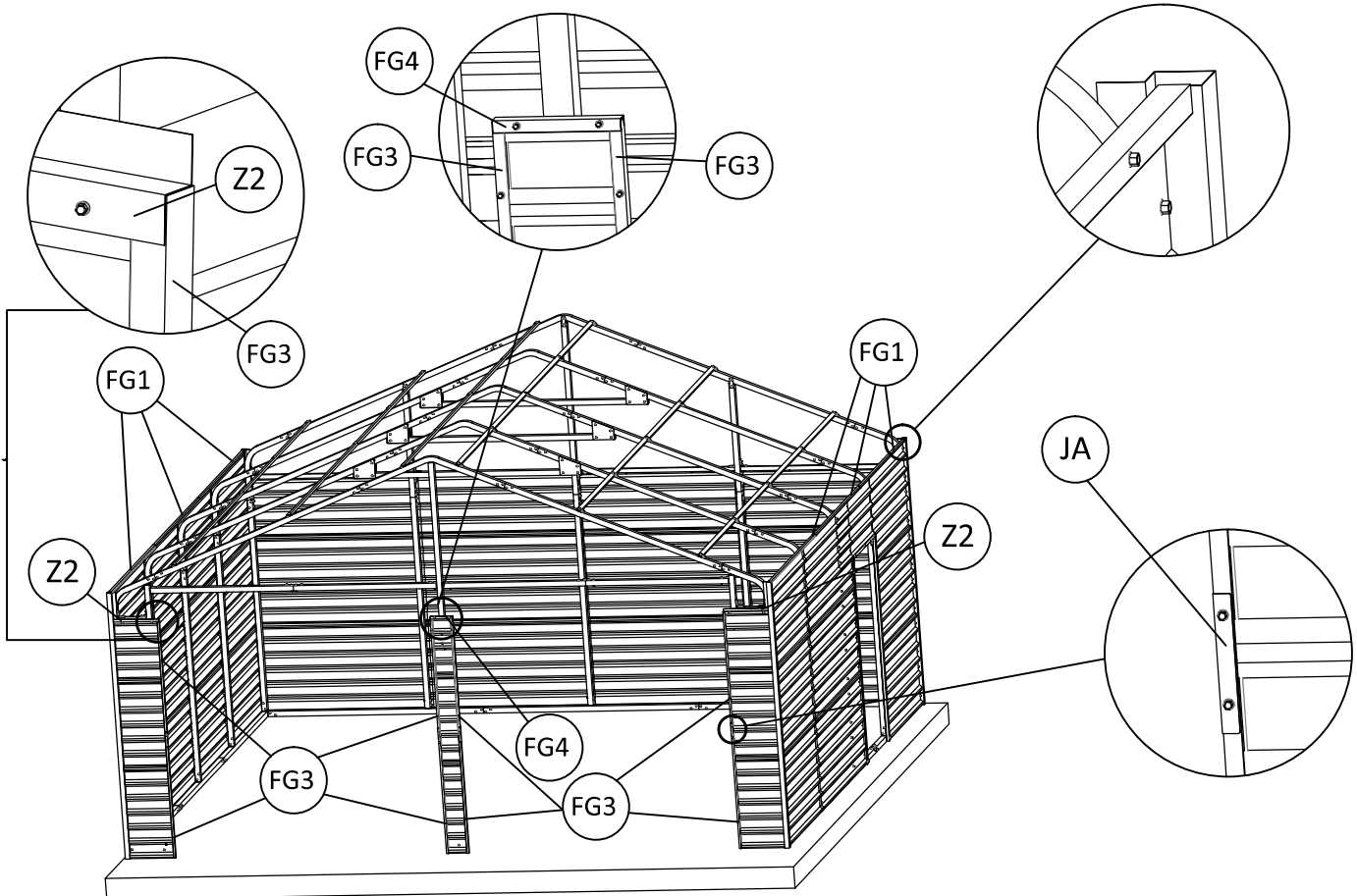

	FG1	6		FG3	8		FG4	1		Z2	2		S12	86
	JA	8												



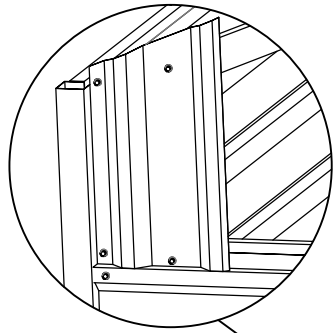







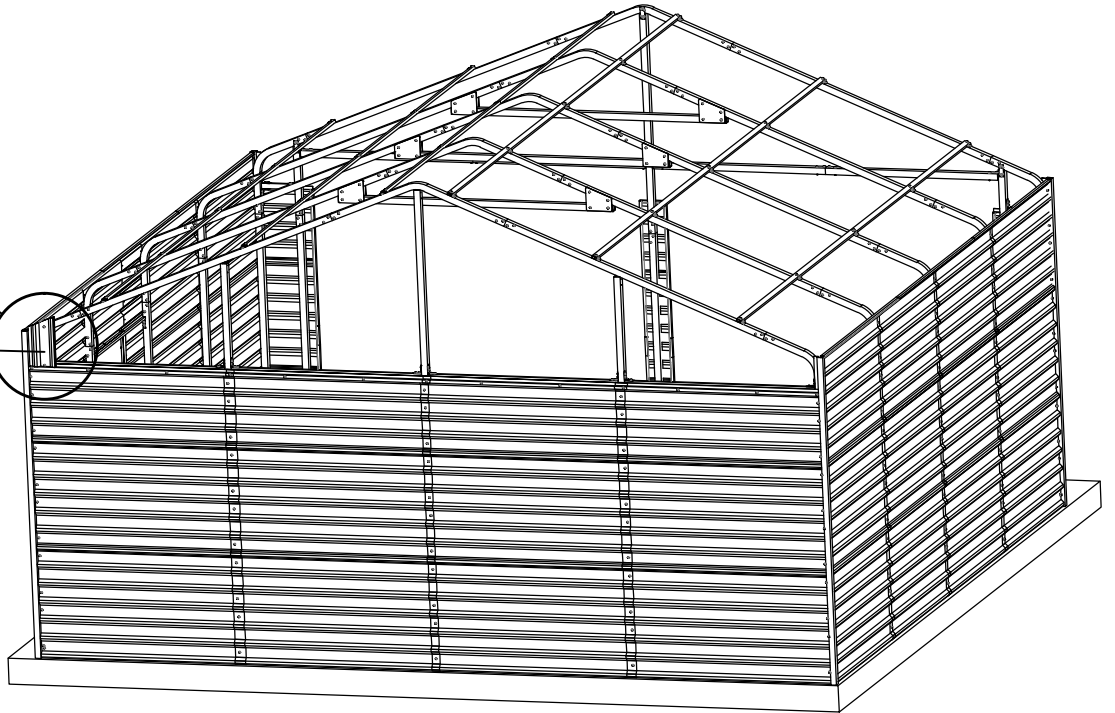

PANEL ASSEMBLY



	PA1	1		S12	4
---	-----	---	---	-----	---







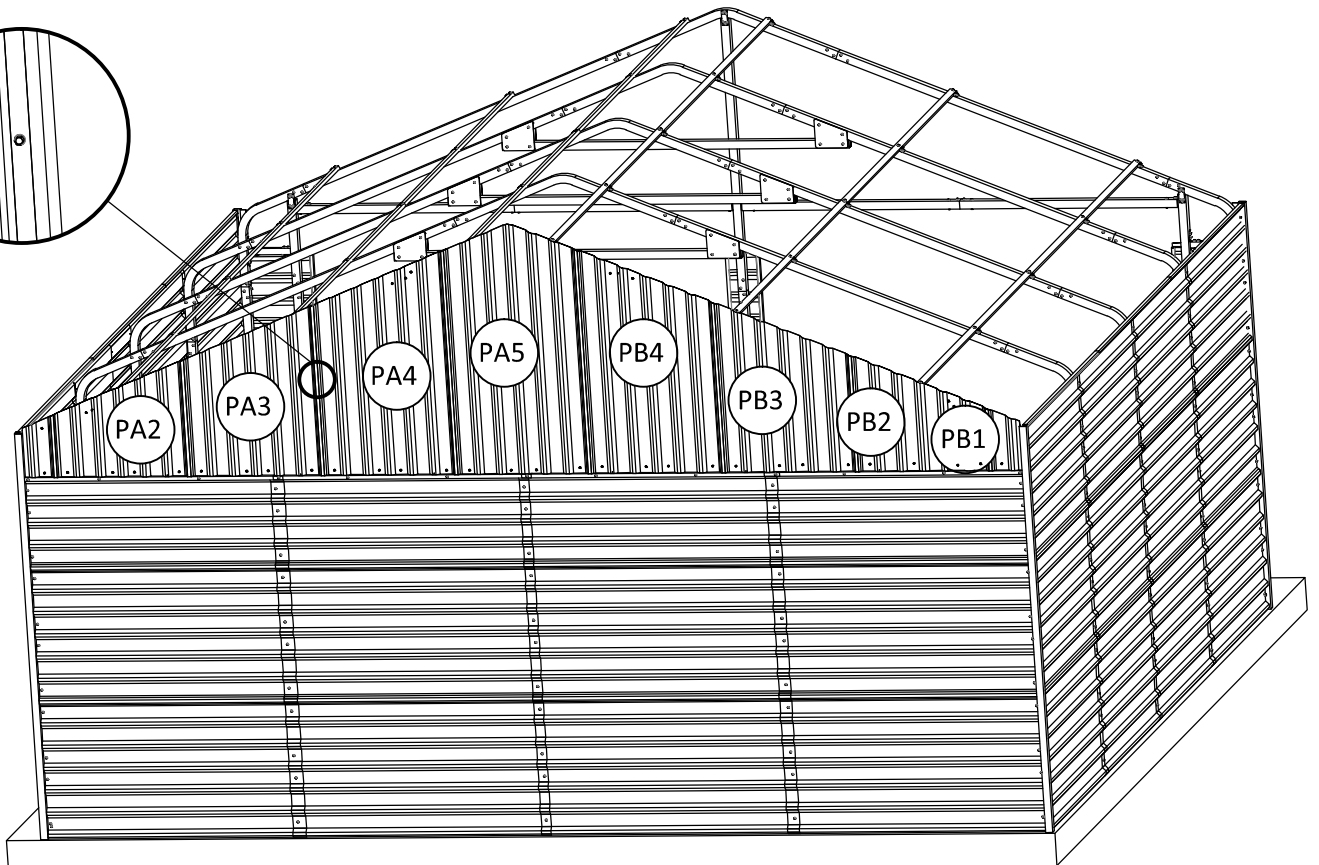
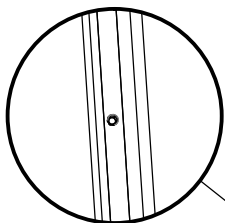



PA1







	PA2	1		PA3	1		PA4	1		PA5	1		PB4	1
	PB3	1		PB2	1		PB1	1		S12	72			

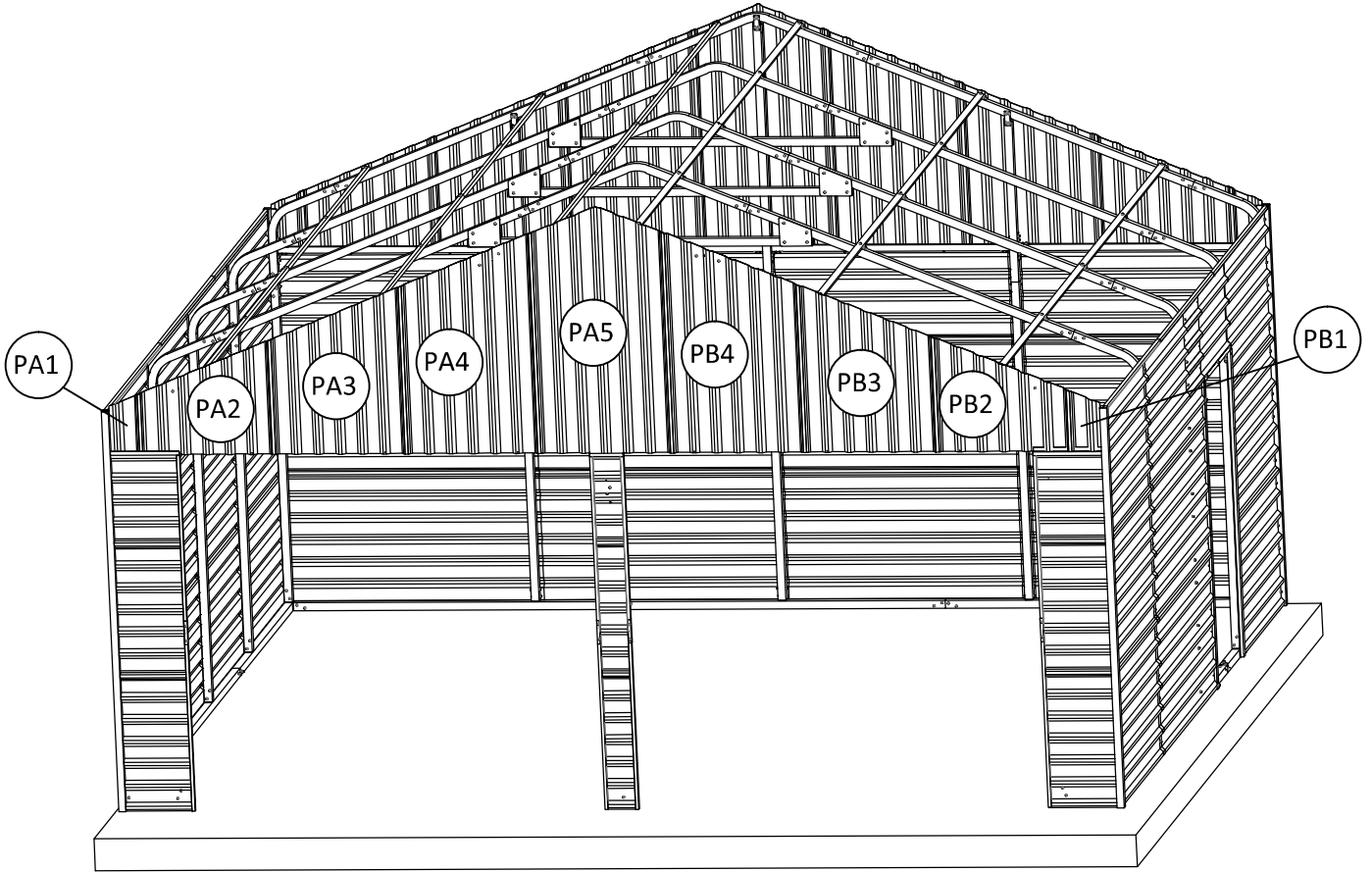

PANEL ASSEMBLY - FRONT WALL



	PA2	1		PA3	1		PA4	1		PA5	1		PB4	1
	PB3	1		PB2	1		PB1	1		PA1	1		S12	72

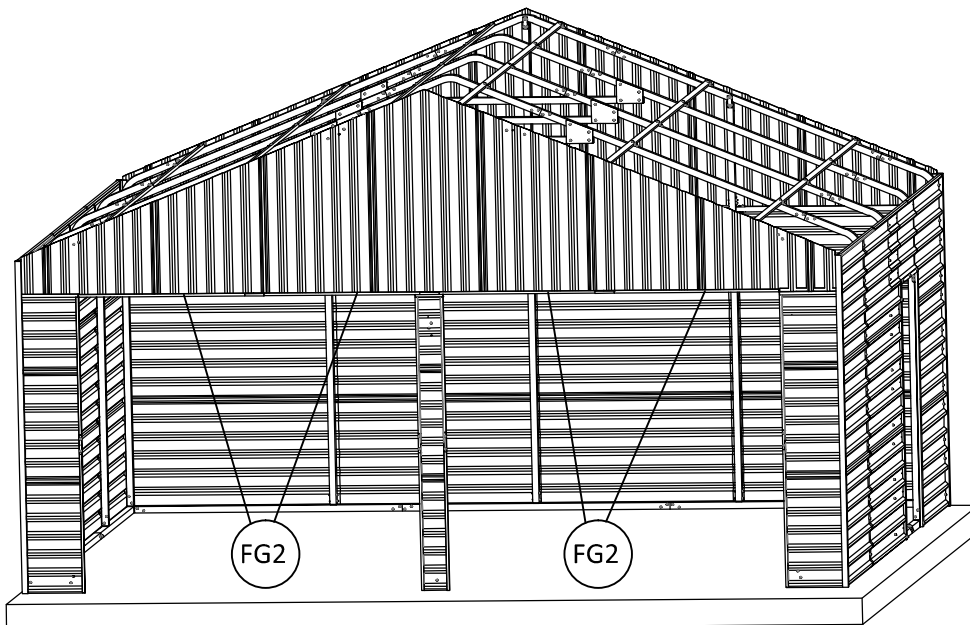

	FG2	4		JA	3		S12	28
---	-----	---	---	----	---	---	-----	----



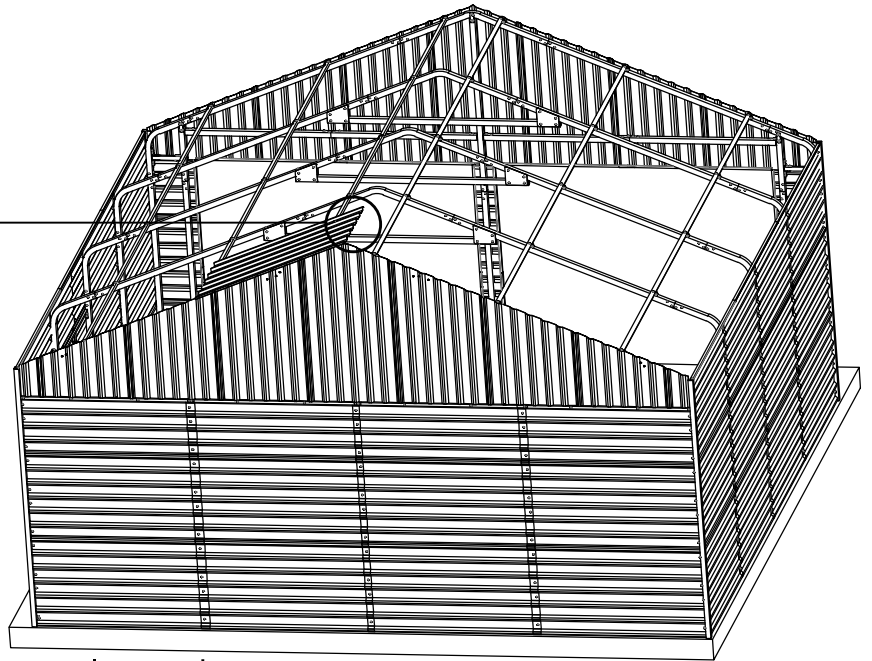
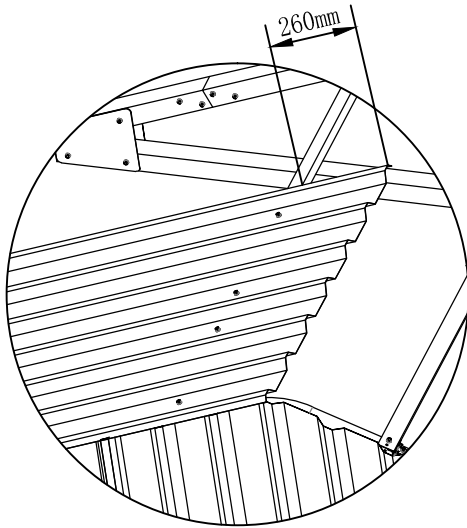

PANEL ASSEMBLY- ROOF

	P8A	1		S12	4
---	-----	---	---	-----	---



S12

When two panels overlap, make sure upper panel covers the lower panel.

	P7A	1		S12	12
---	-----	---	---	-----	----

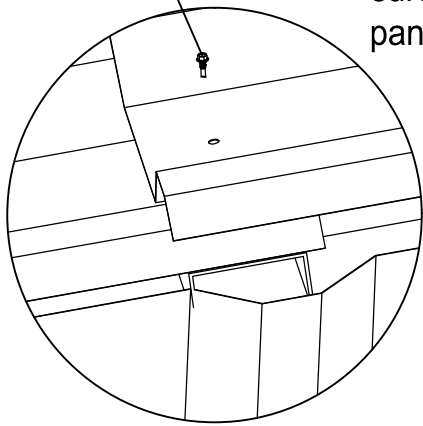



P7A

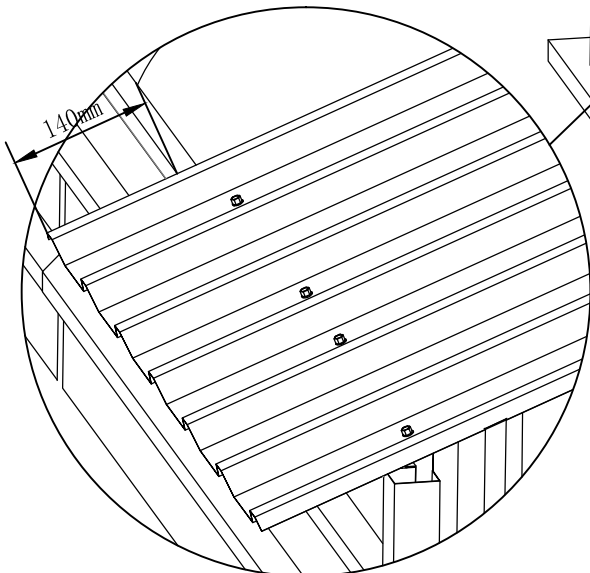
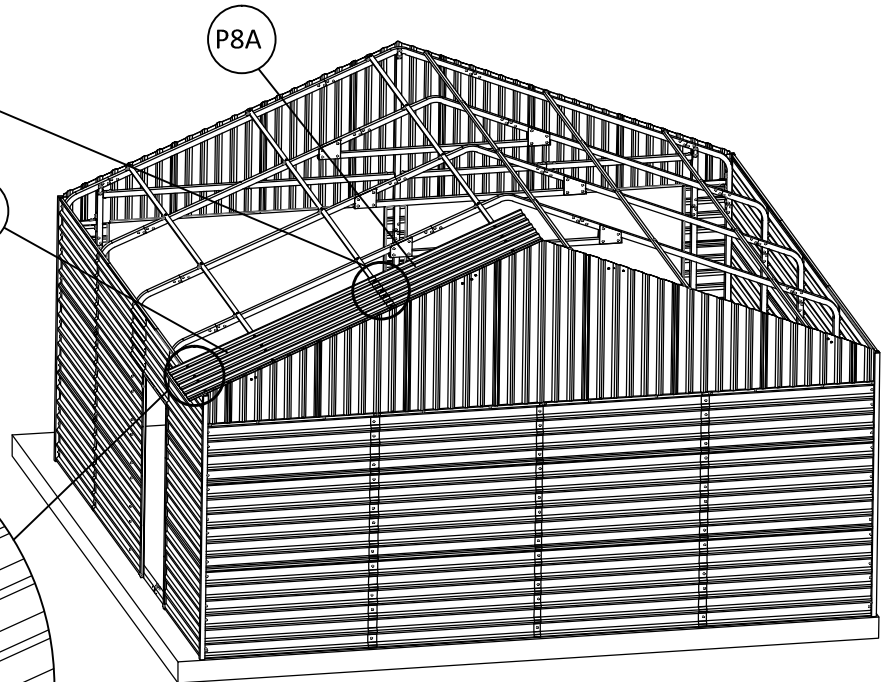

P8A



PANEL ASSEMBLY- ROOF

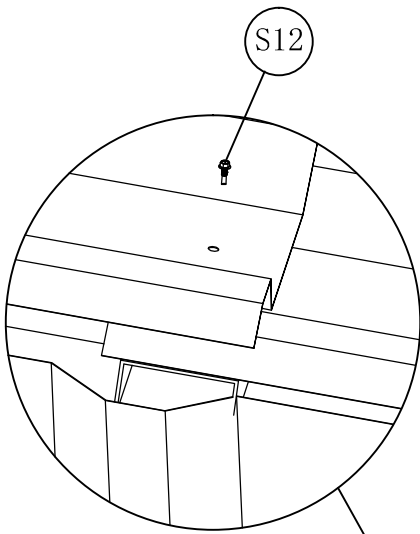
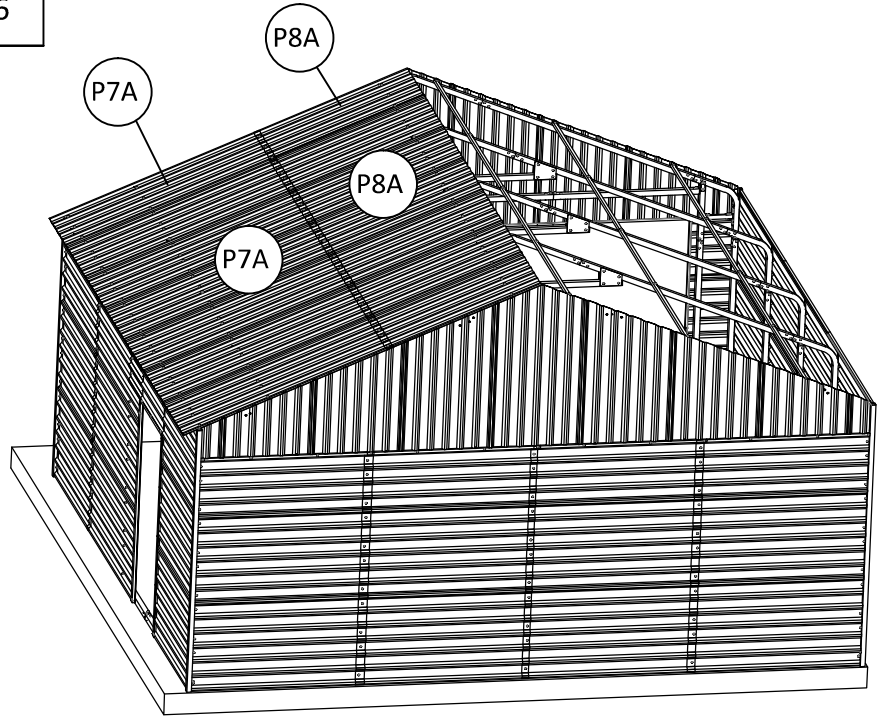



	P7A	6		P8A	6
	S12	80			

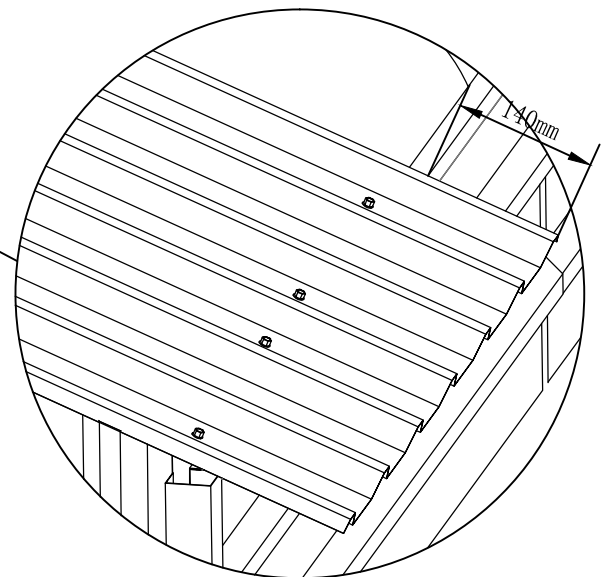
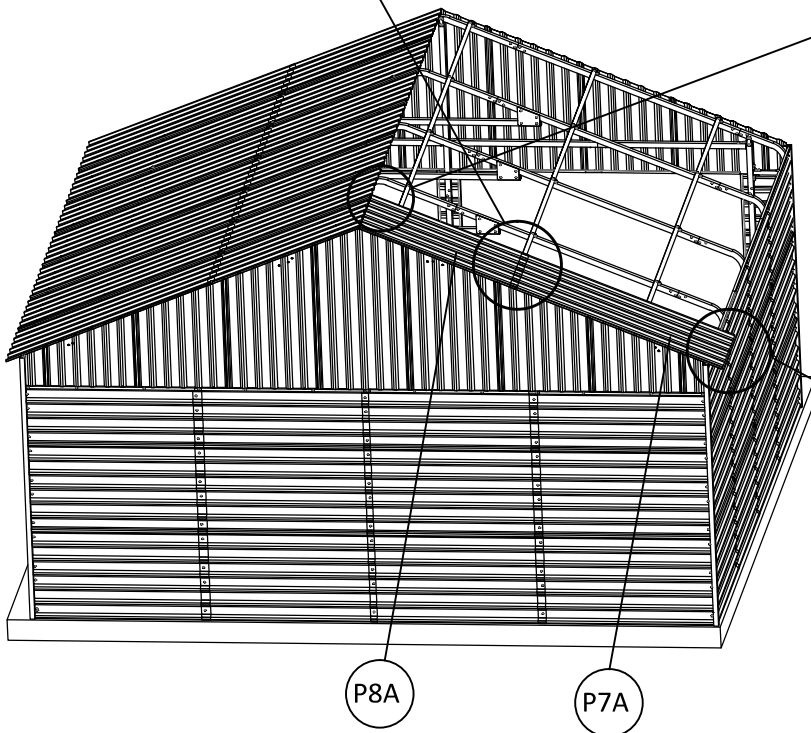
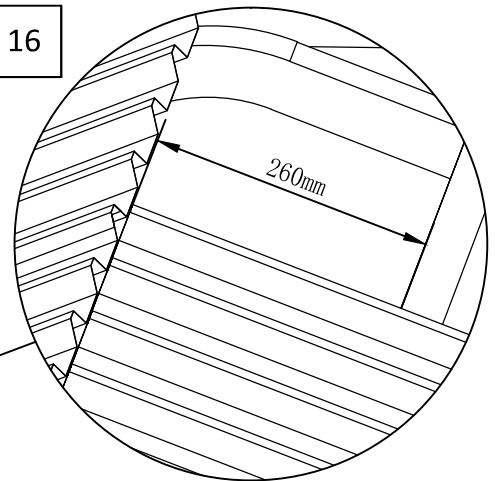







	P7A	1		S12	16
	P8A	1			

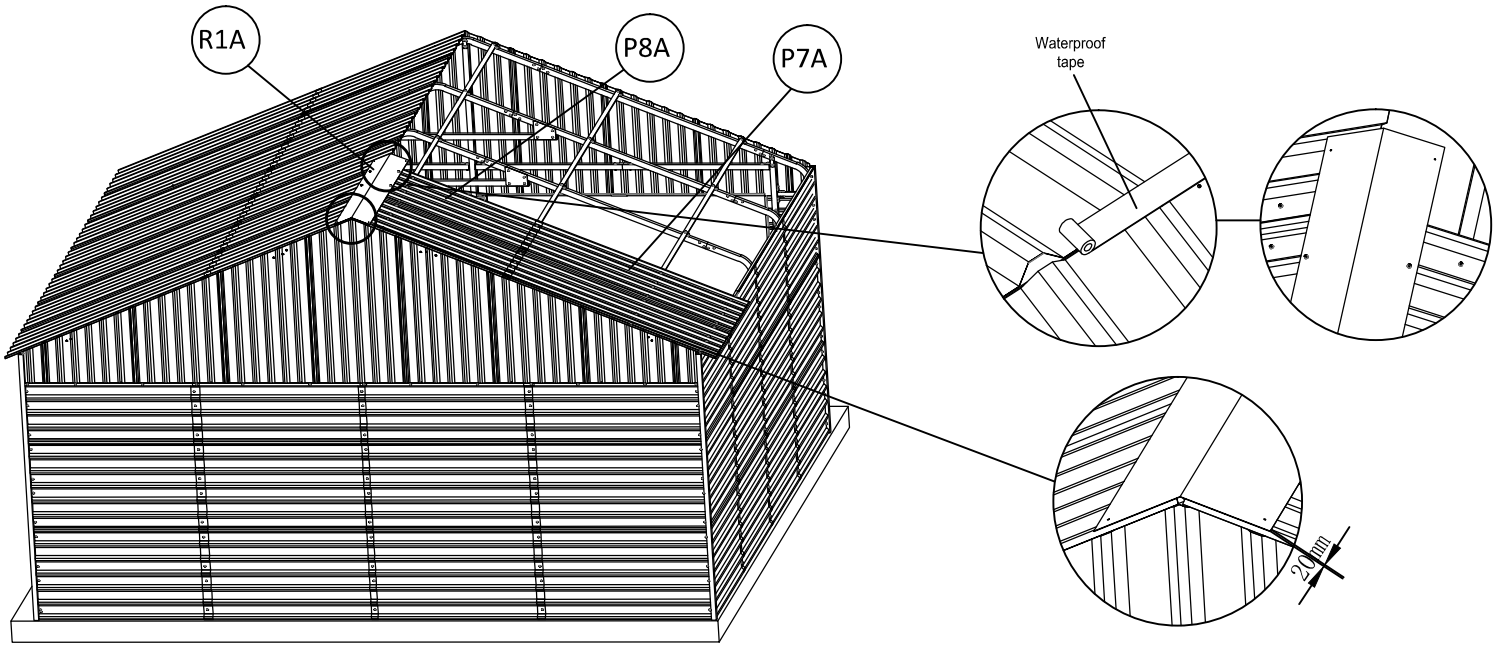

PANEL ASSEMBLY- ROOF

	P7A	1		P8A	1		R1A	1		S12	20		Waterproof tape
---	-----	---	---	-----	---	---	-----	---	--	-----	----	---	-----------------





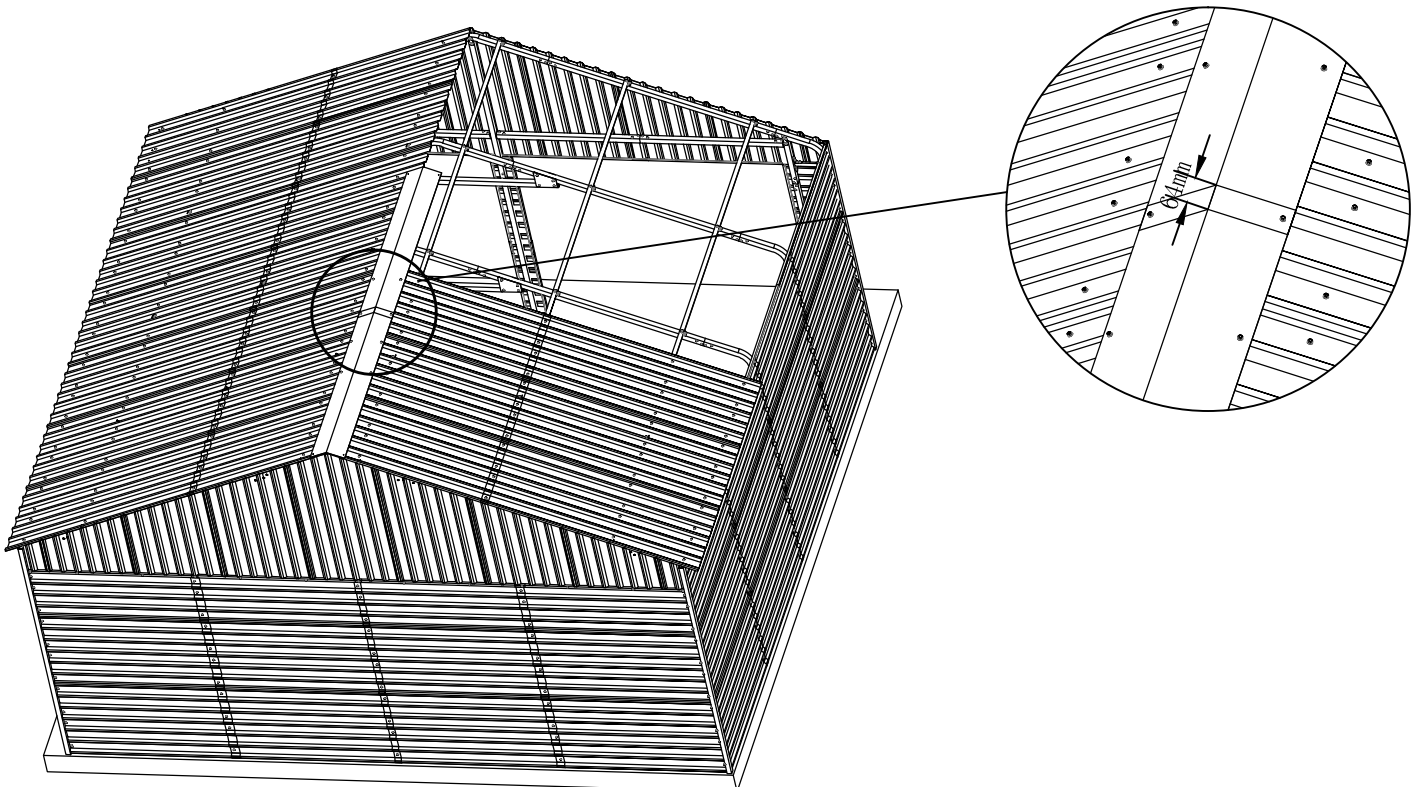

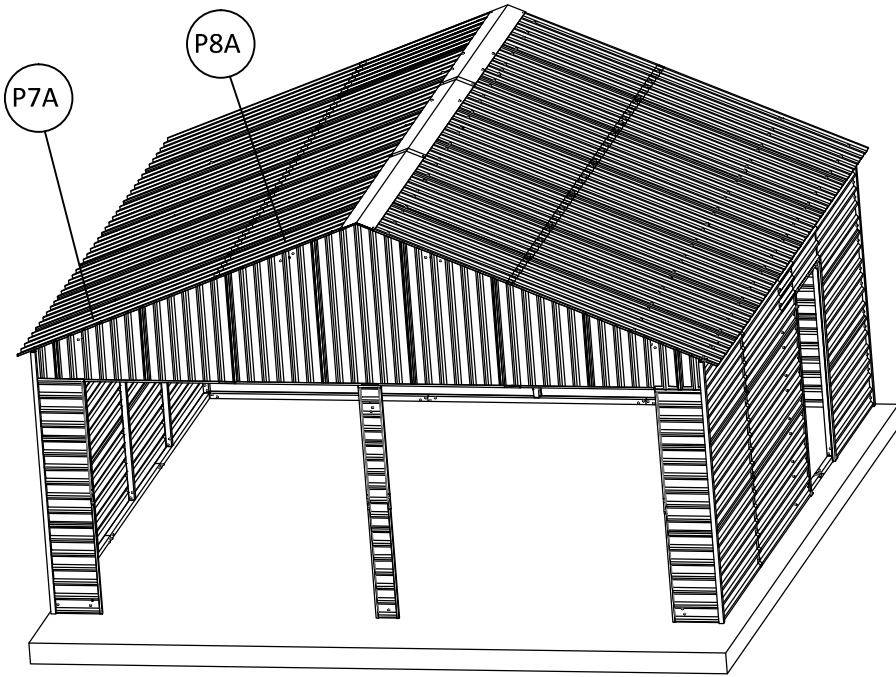

	P7A	1		P8A	1		R1A	1		S12	20		Waterproof tape
--	-----	---	--	-----	---	--	-----	---	--	-----	----	--	-----------------



SHED ASSEMBLY- ROOF



	P7A	4		P8A	4
	S12	54		R1A	1
	Waterproof tape				

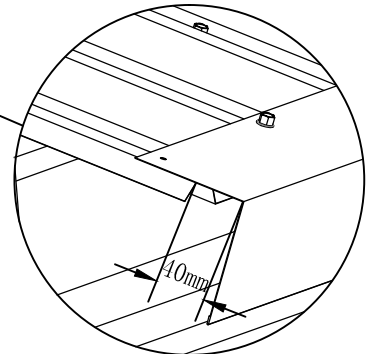
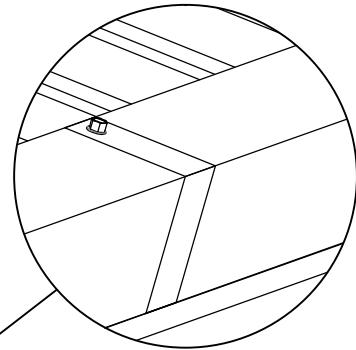
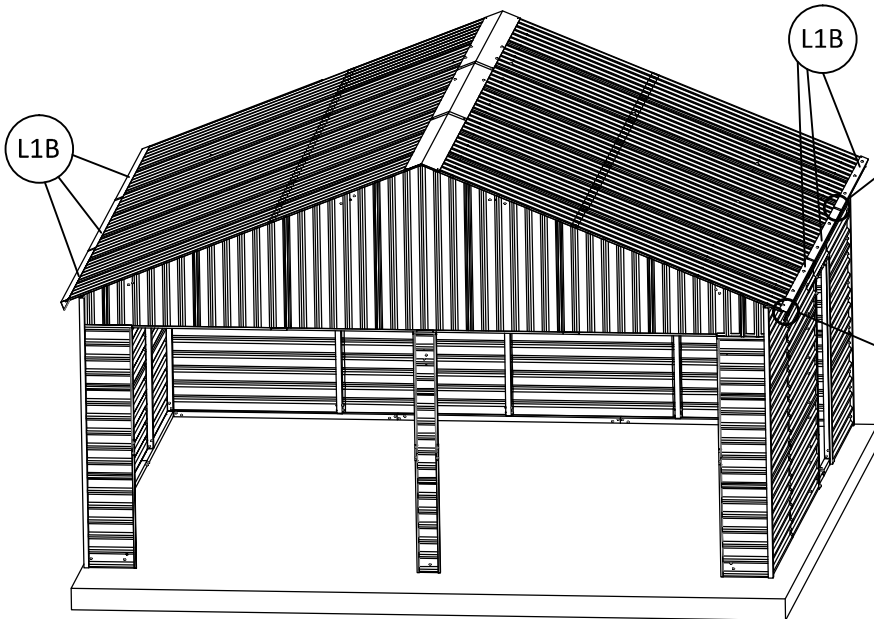

	L1B	6		S12	20
---	-----	---	---	-----	----

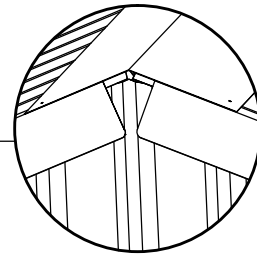
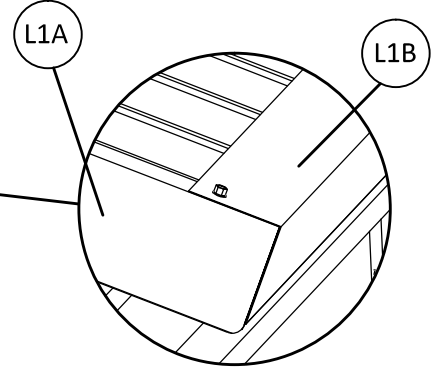
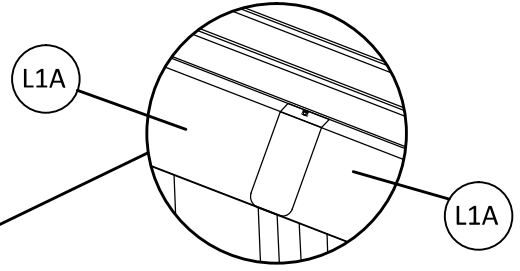
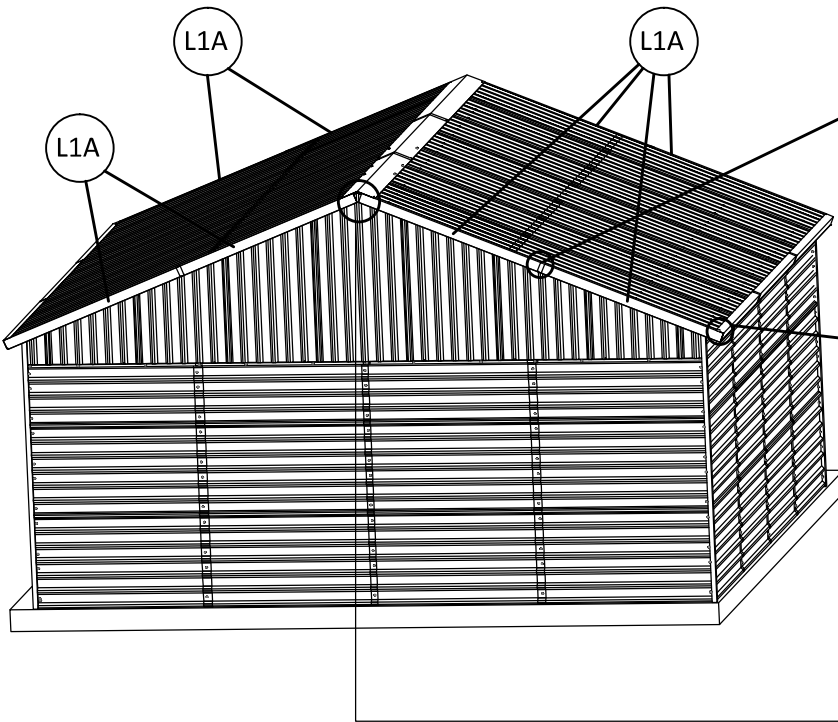

SHED ASSEMBLY- ROOF

	L1A	8		S12	20
---	-----	---	---	-----	----





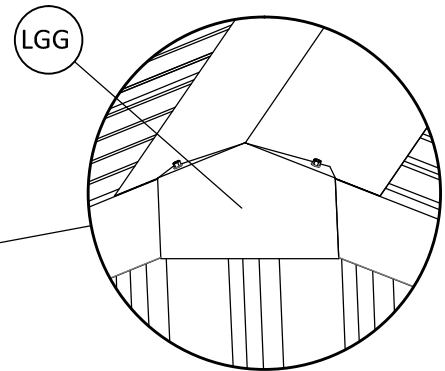
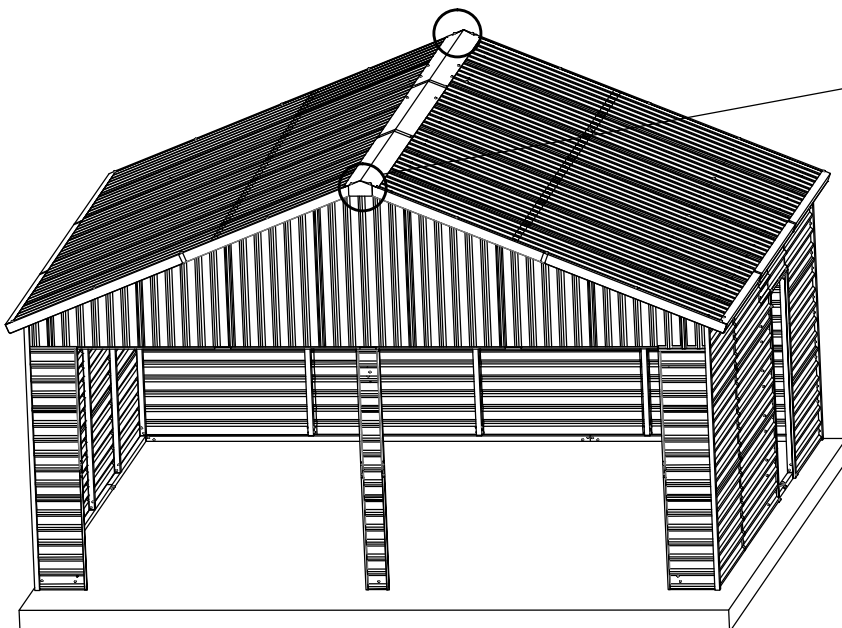



	LGG	2		S12	4
---	-----	---	---	-----	---





DOOR ASSEMBLY - SIDE DOOR

STEP 1.

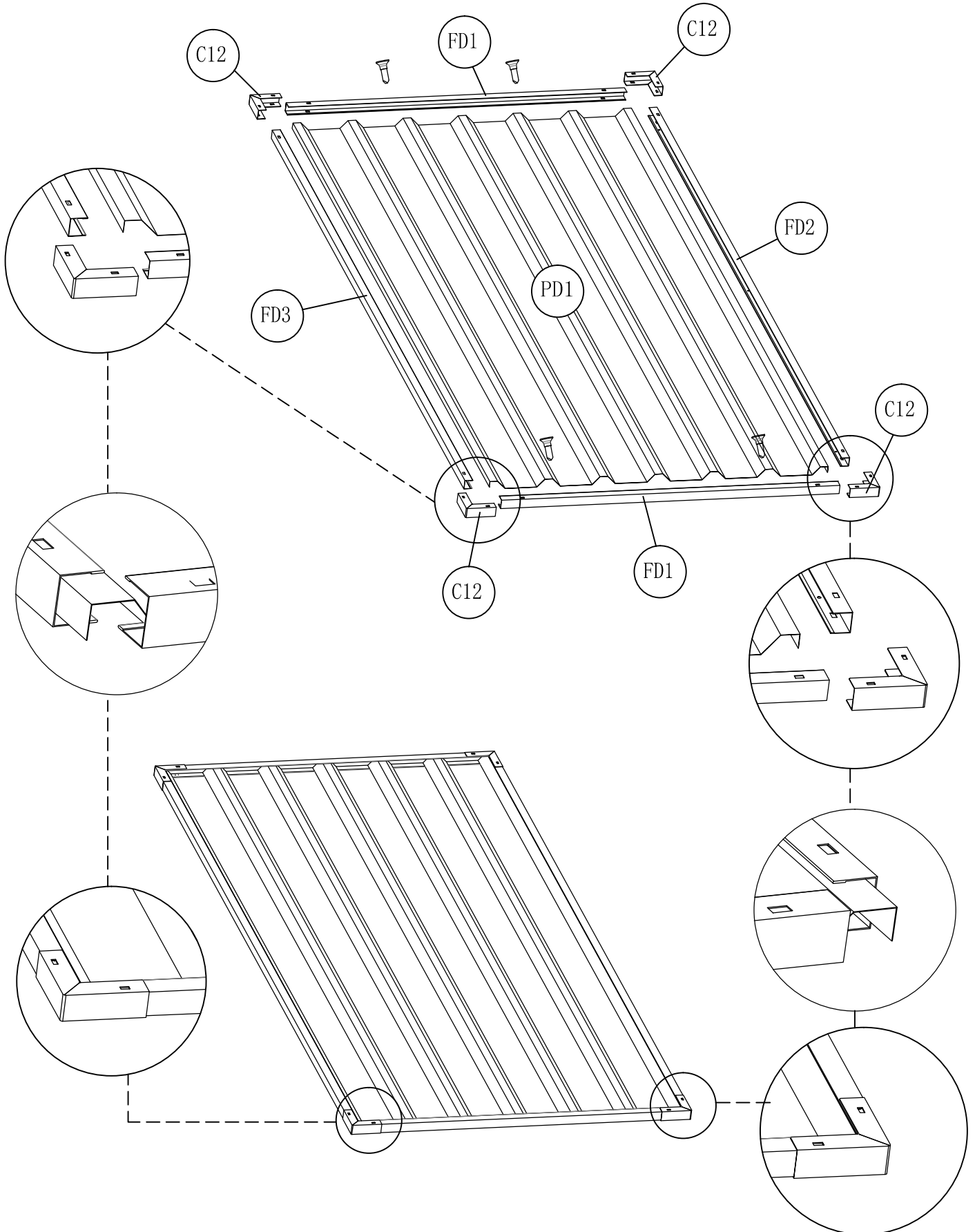
	PD1	1		FD1	2		FD3	1
	C12	4		FD2	1		S1	4

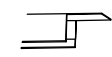
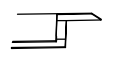

DOOR ASSEMBLY - SIDE DOOR

	FDU1	1		FDU2	2
	S1	6		L1A	6

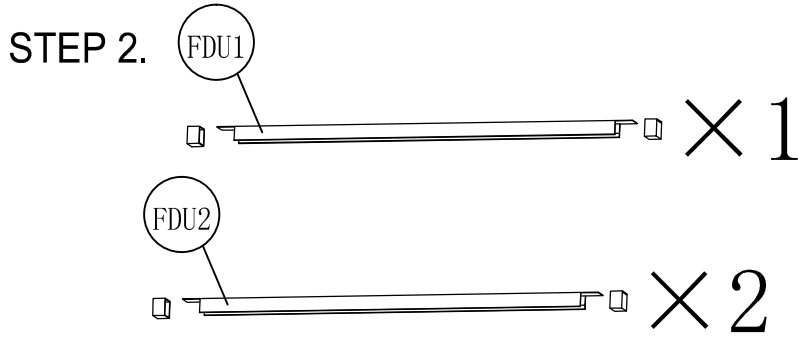



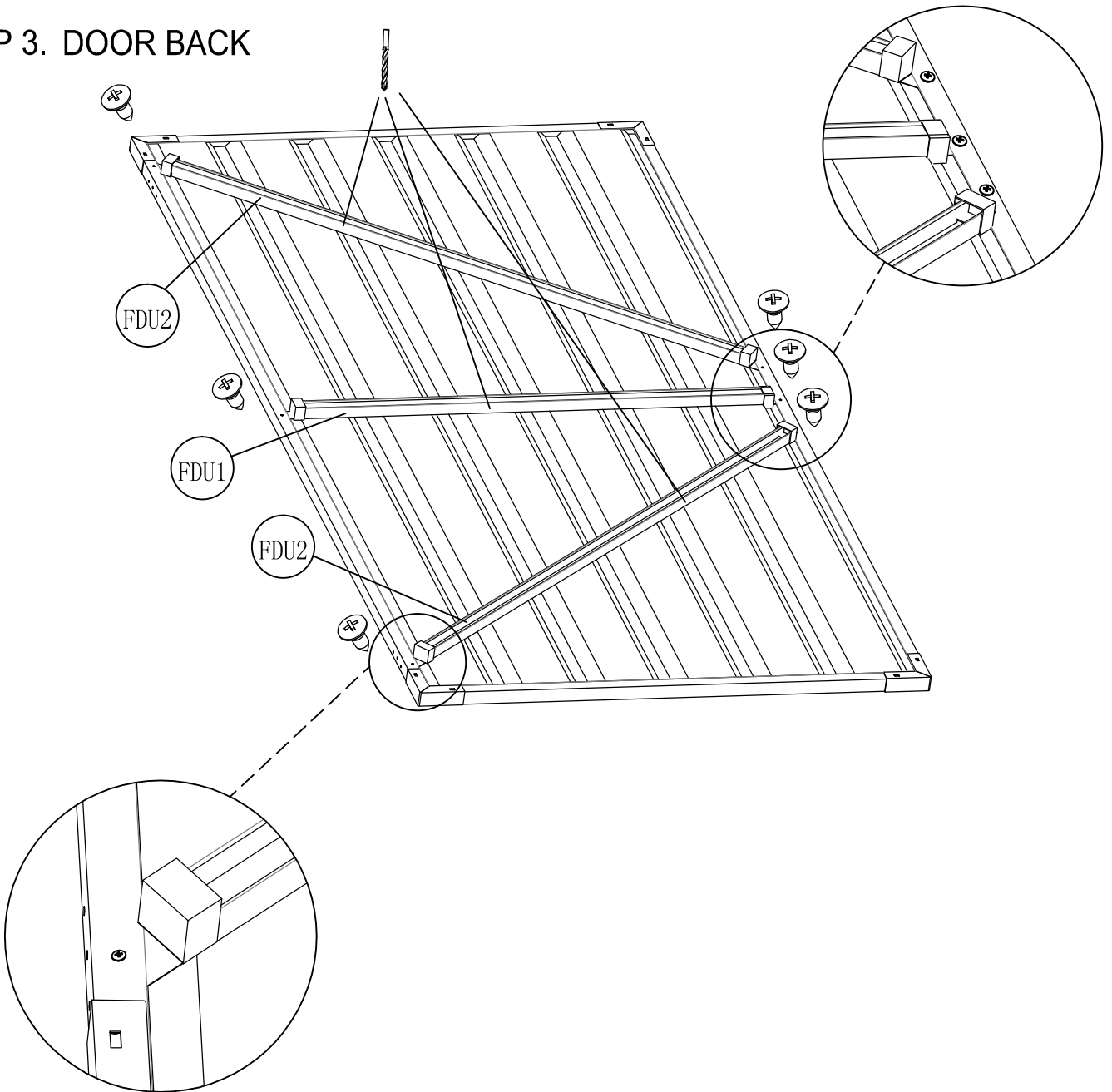

STEP 3. DOOR BACK

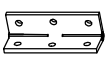

DOOR ASSEMBLY - SIDE DOOR

STEP 4. DOOR FRONT

	SH1	2		S1	18
	S16	6		L3	18
	MSA	2			

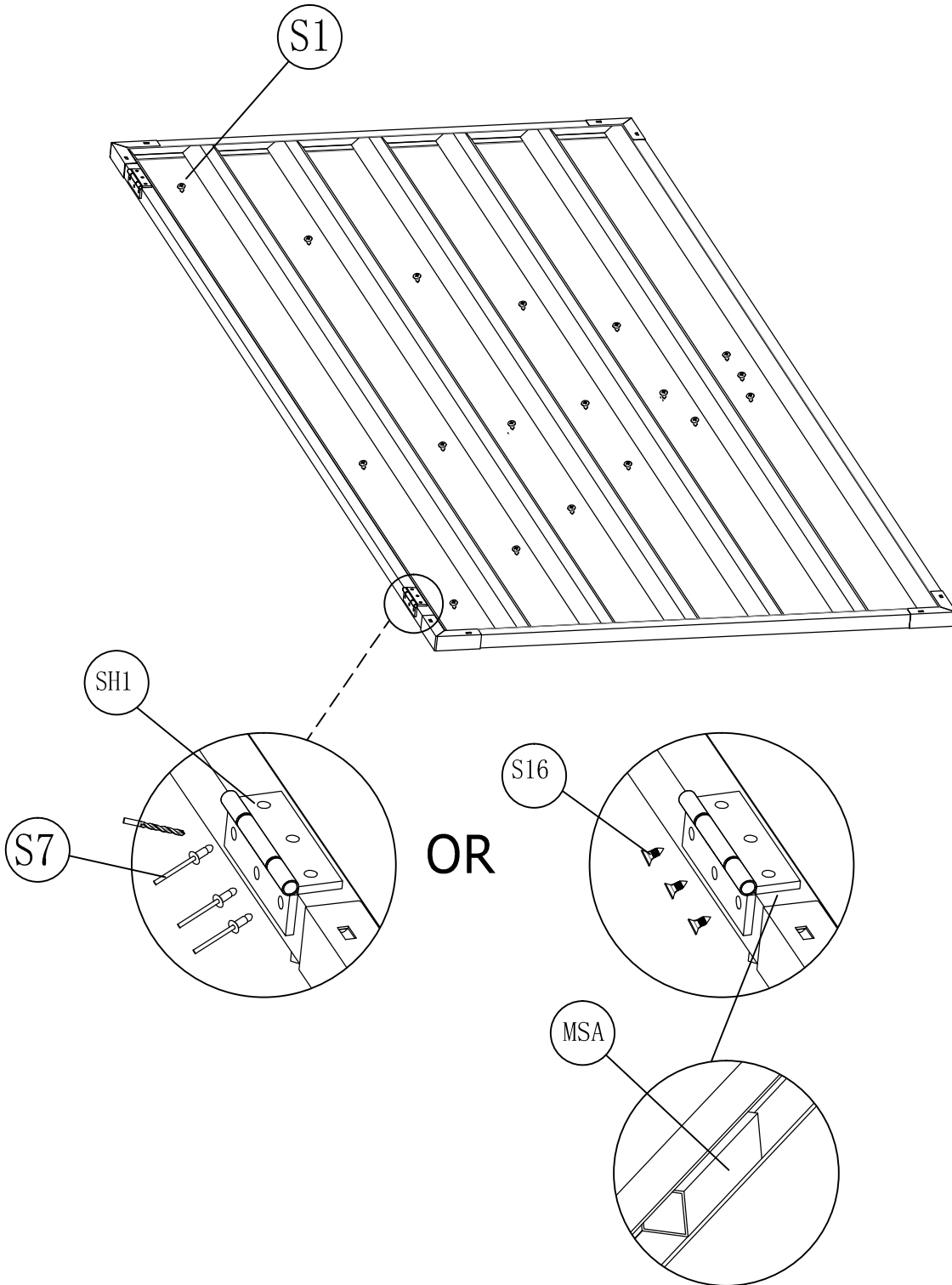

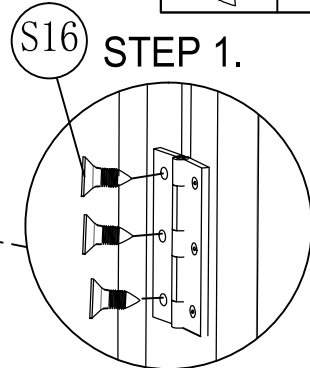
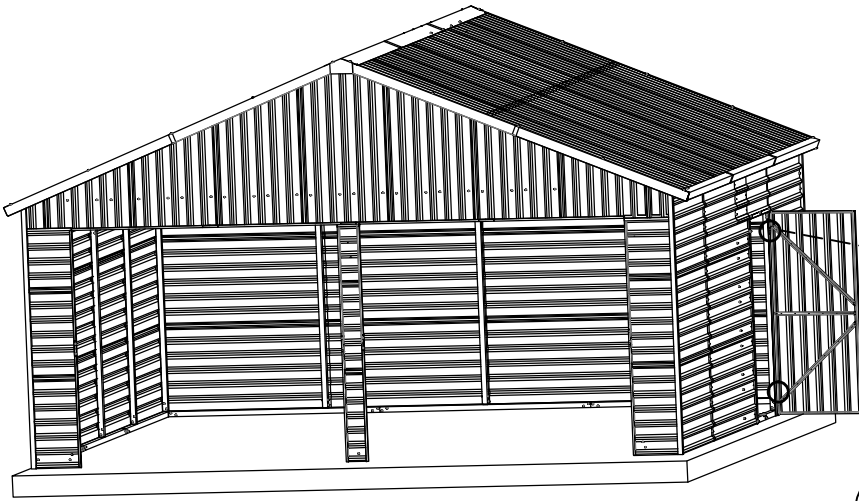

Adjust the position of the door, mark on TE1 and use the drill to drill through, then use S7 or S16 to connect.

	S16	12
---	-----	----

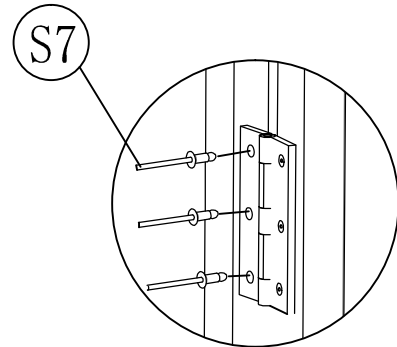

OR





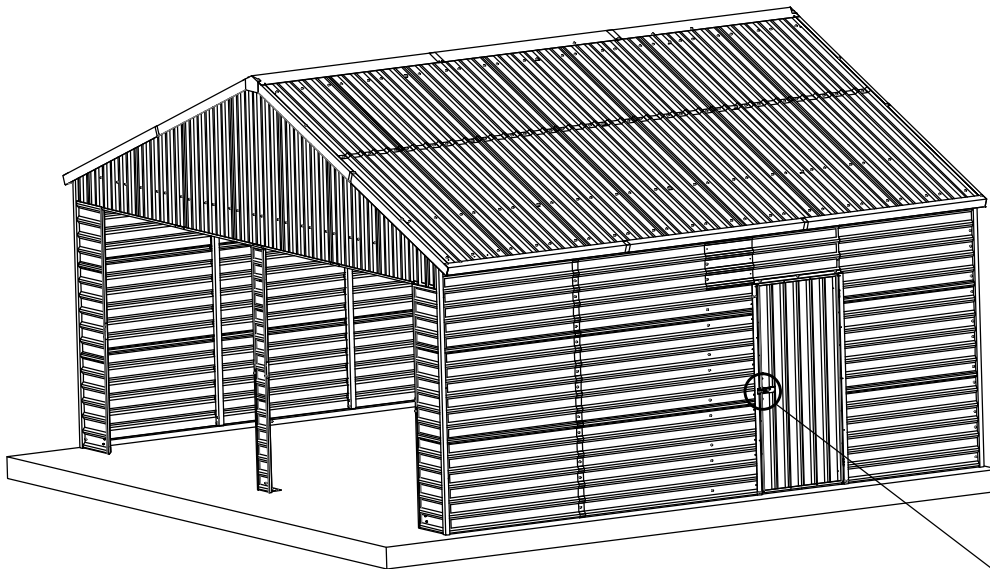

	H1	1
	S16	6

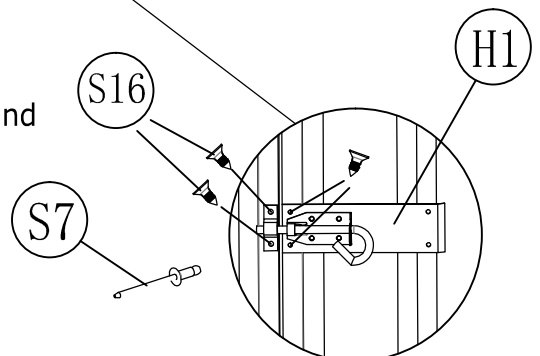

Install the latch in position as shown and fix with S16 or S7.







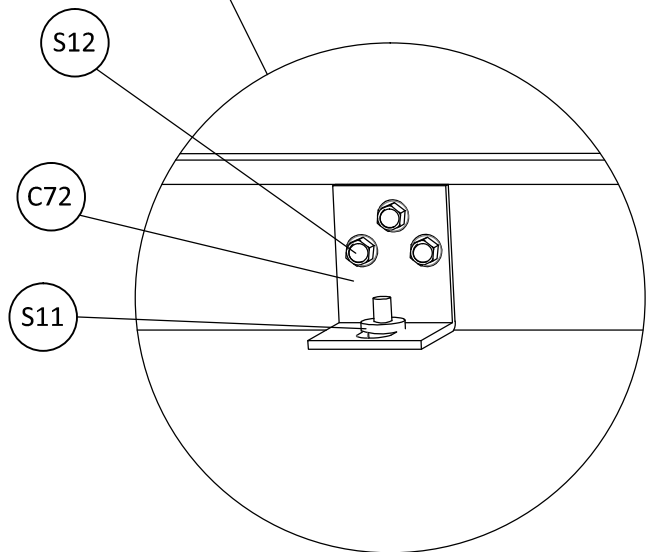
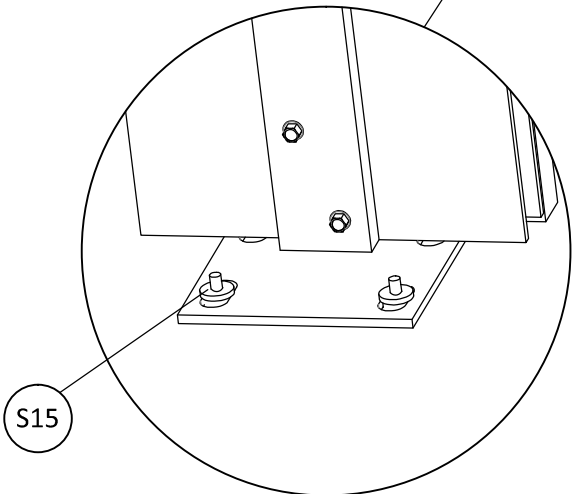
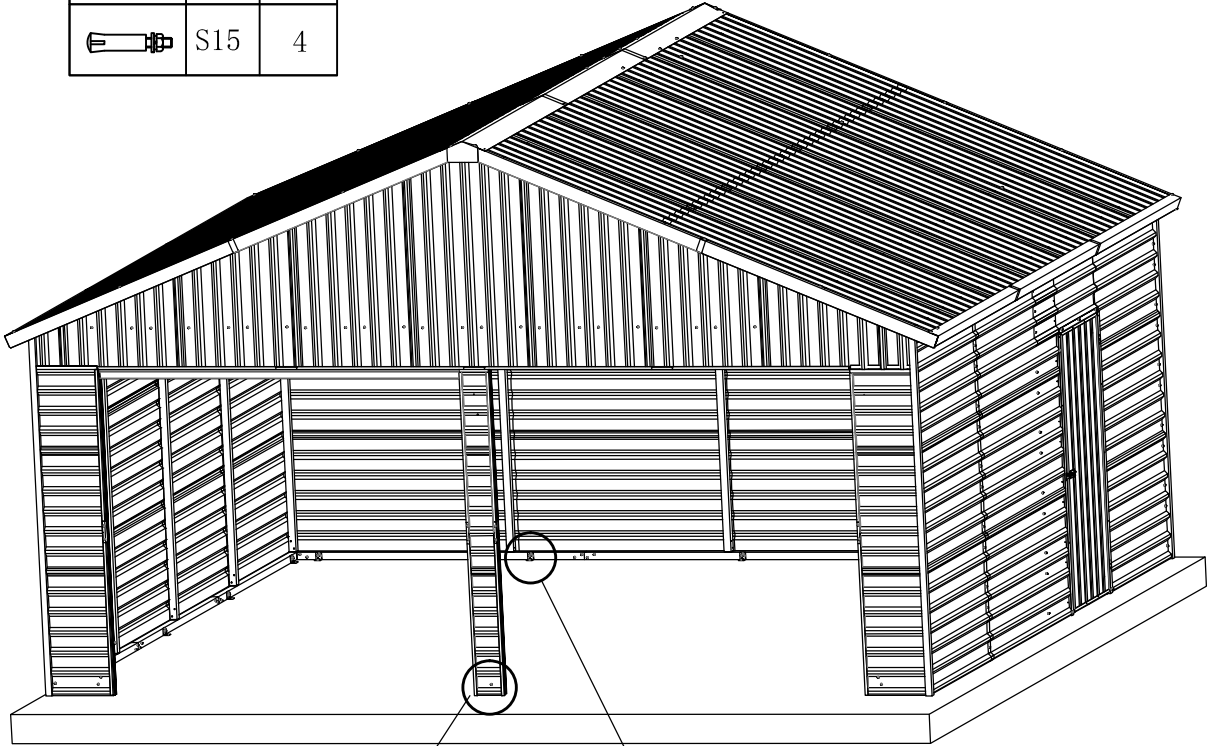

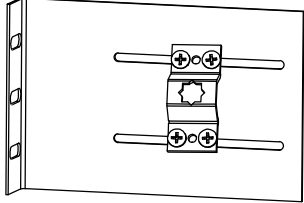
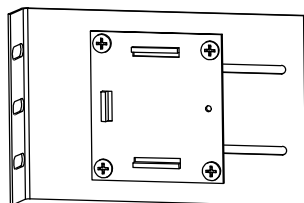

SHED ASSEMBLY

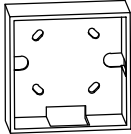
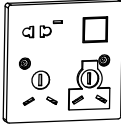
	C72	14		S12	42
	S11	14			
	S15	4			

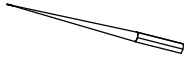
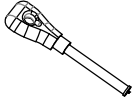

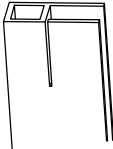
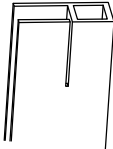
ASSEMBLY OF THE DOOR MAY REQUIRE THE FOLLOWING PARTS

						
A		B				
						
C	D	E	F	H	I	J
						
K	L	GR1	GR2			
						
S12	S13					

SHED ASSEMBLY - ROLL UP DOOR

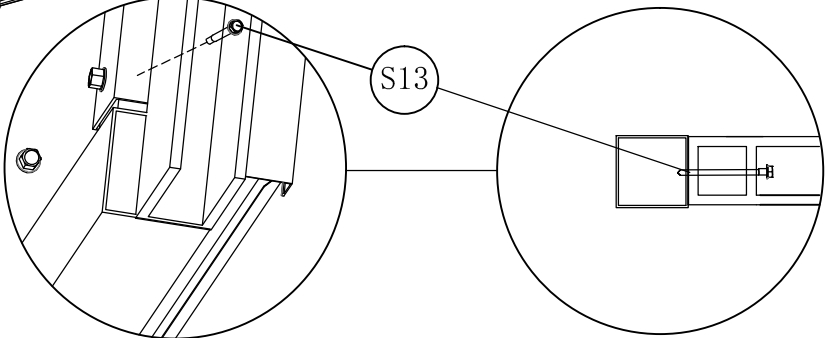
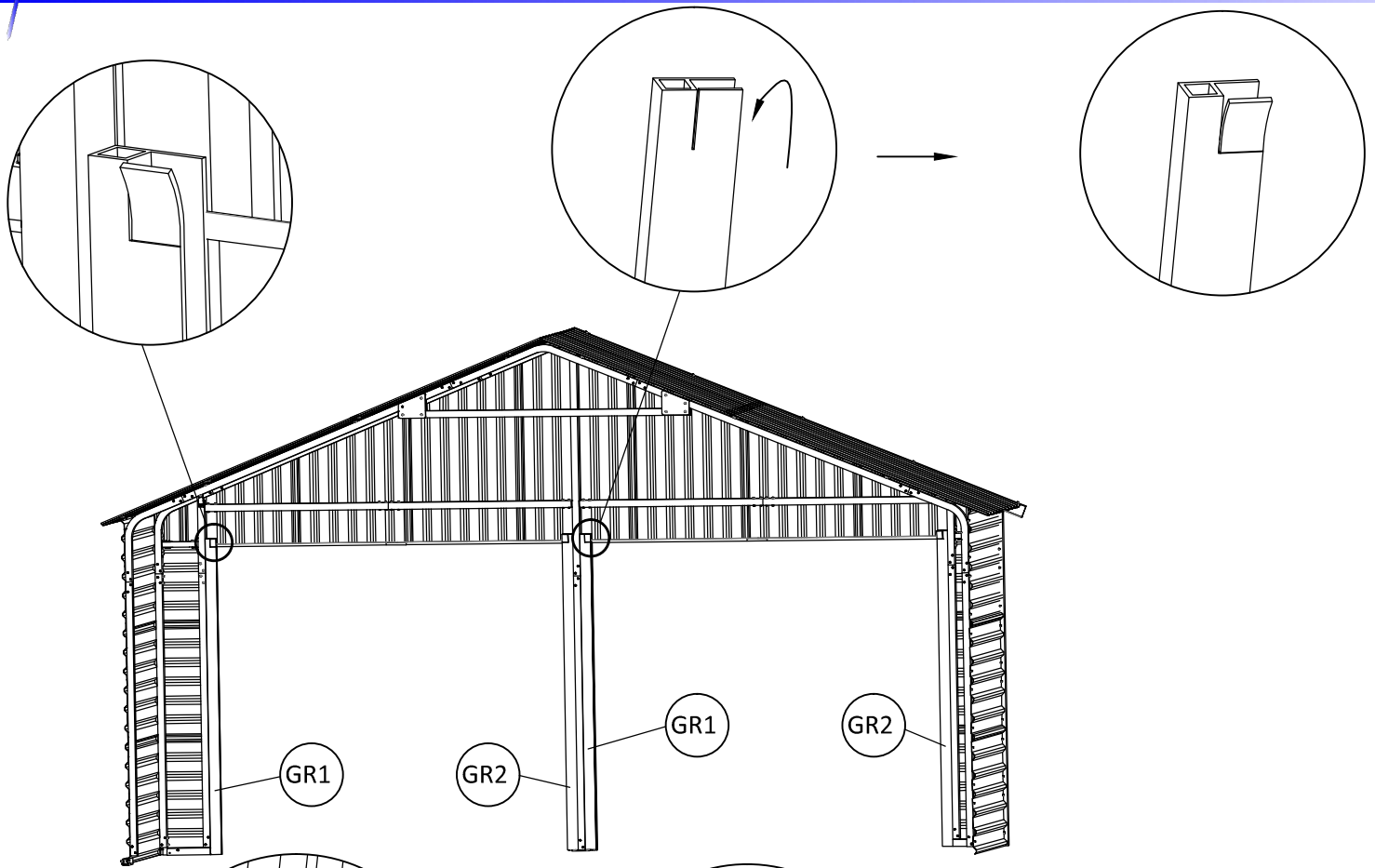

MAKE SURE THAT THE CENTERS OF A AND B ARE ON THE SAME HORIZONTAL POSITION.

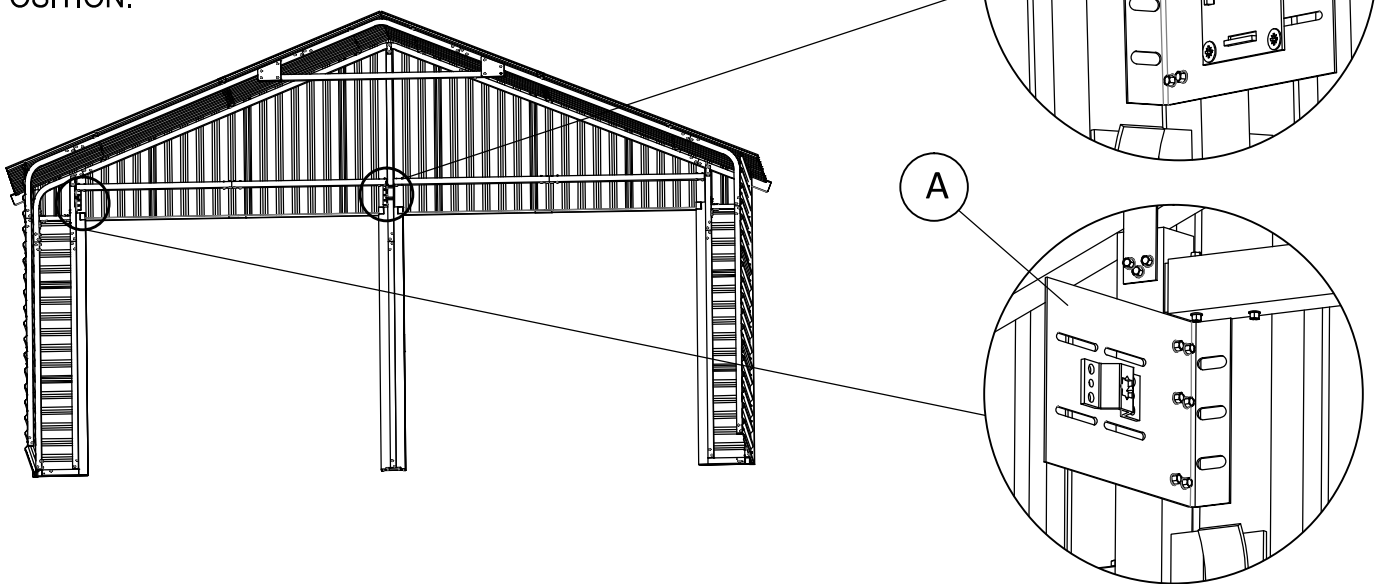

SHED ASSEMBLY - ROLL UP DOOR

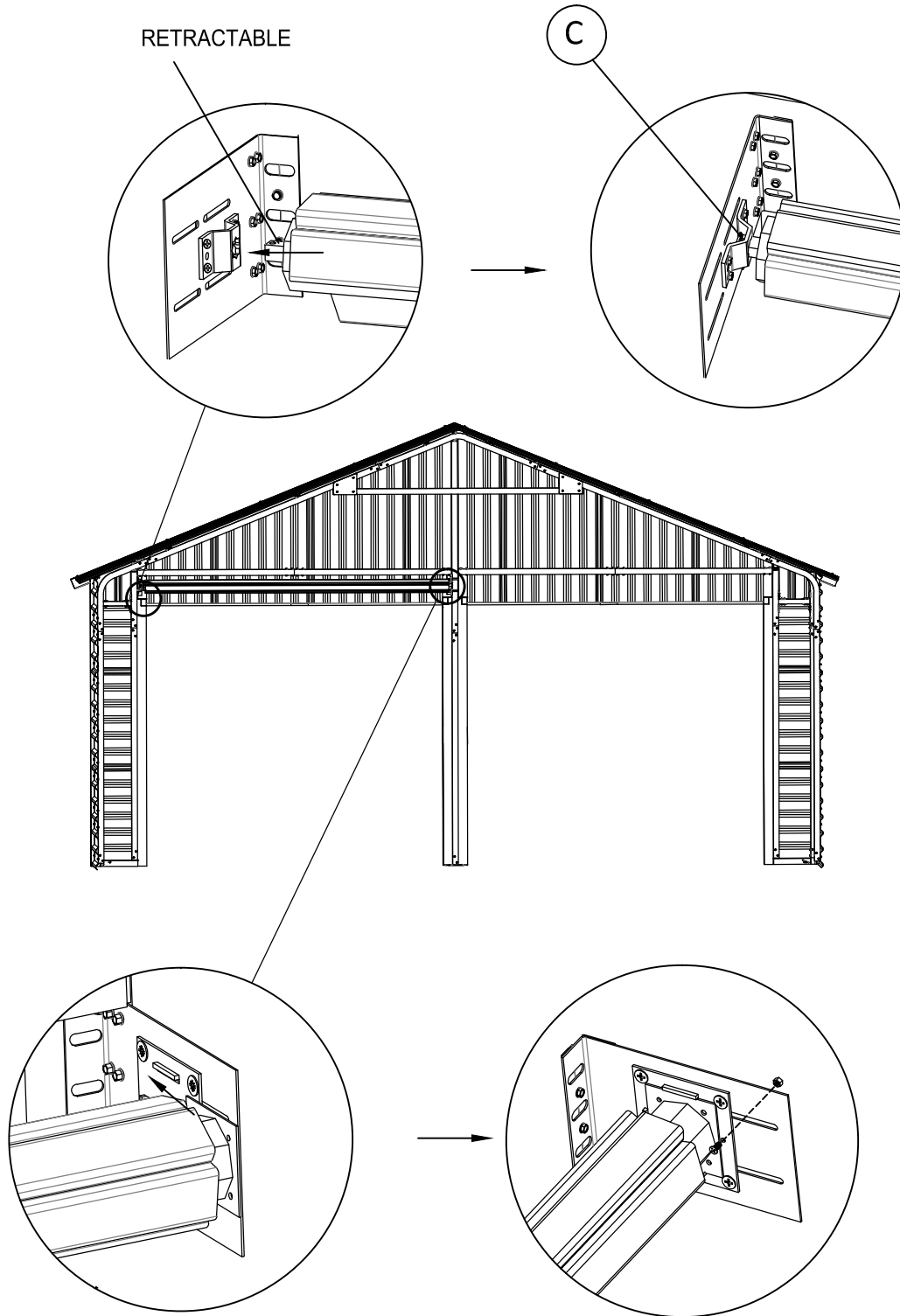

SHED ASSEMBLY - ROLL UP DOOR

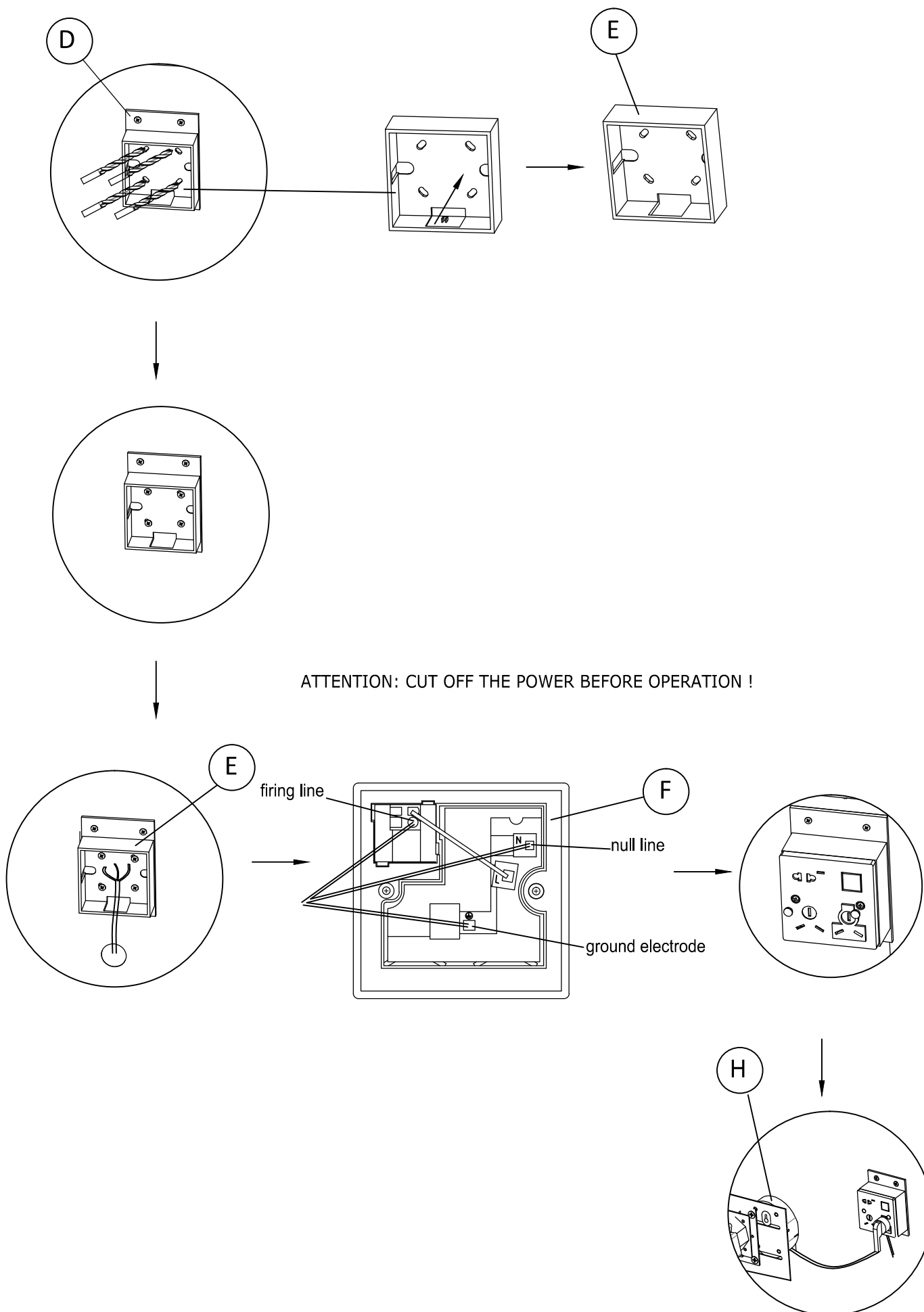

SHED ASSEMBLY - ROLL UP DOOR

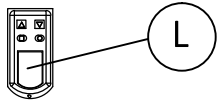

POWER-ON, THEN CONTROL THE REMOTE CONTROL, SLOWLY INSERT THE ROLLER DOOR INTO GR1 AND GR2.

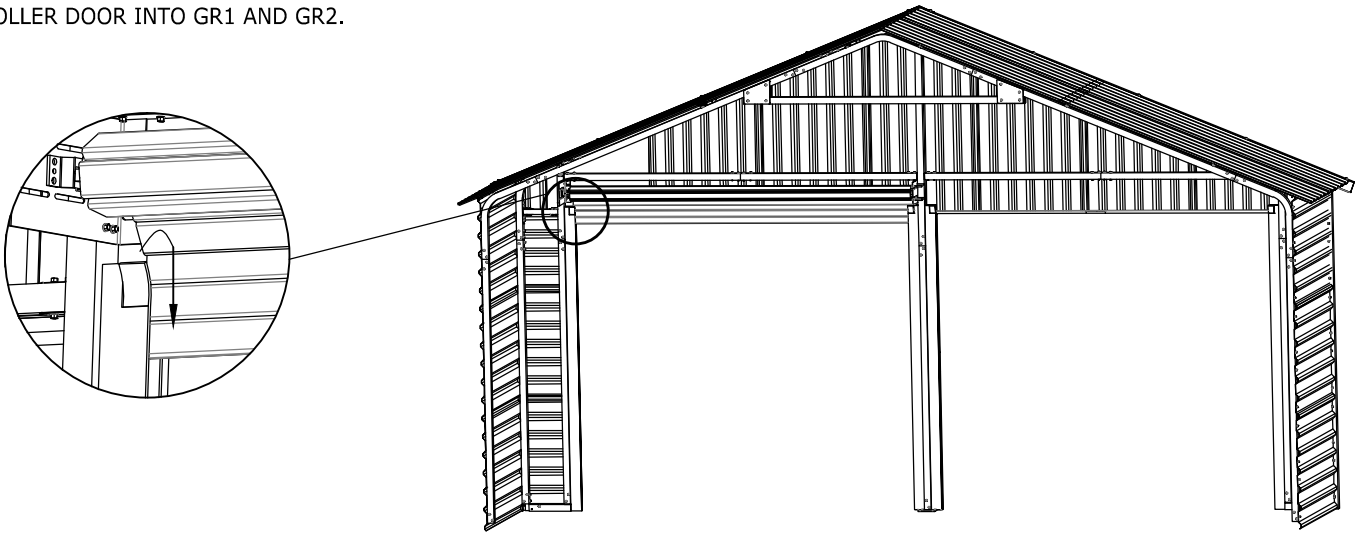

Install another rolling door in the same way.

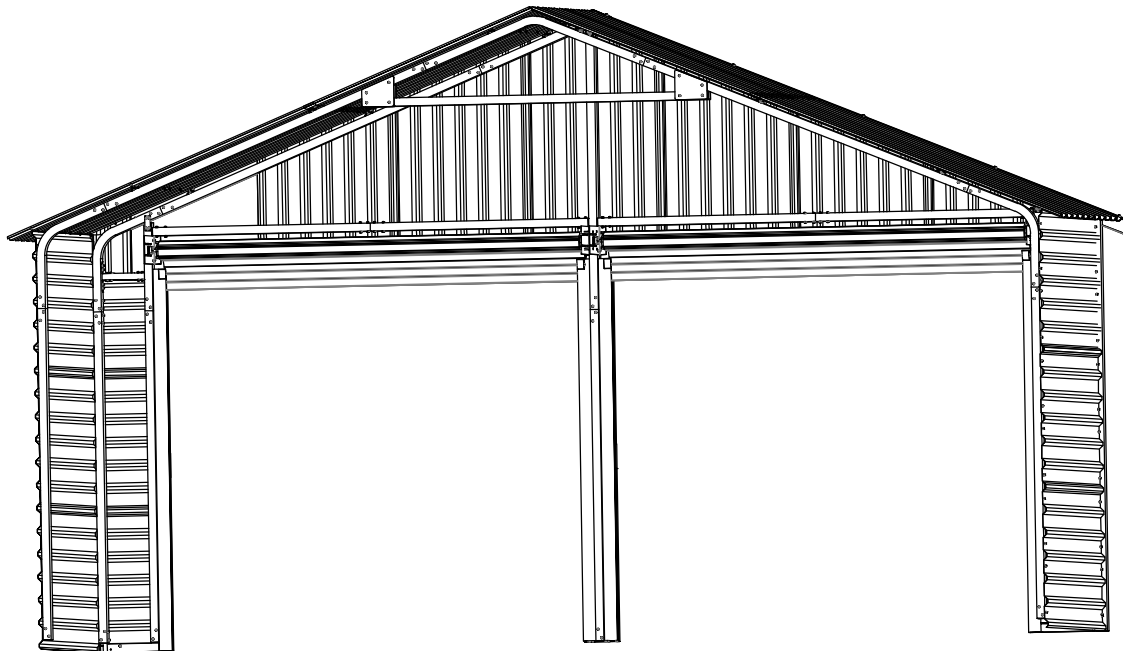

SHED ASSEMBLY

Step:(the yellow regulating hole is lower limit, the blue regulating hole is upper limit,SYMBOL '+' is increasing distance, SYMBOL '-' is reduce distance)

- 1: You need install the roller door and remote control and fix them well. Then, plug in and try to know well about the position of button UP, DOWN, STOP, UNLOCK on remote control.
 - 2: Run down the door, when the roller door get close to the ground, press the STOP button or stop automatically.
 - 3: Please insert the limit adjusting rod (I) into the blue regulating hole, and observe the direction of the '+' and '-'.
 - 4: Run up the door, at meantime, turn the adjusting rod to '-' until it stops.(if it doesn't stop,please run down the roller door to get close to ground again, and run up the door, at meantime, turn the adjusting rod to '-' until to stop again.You can loop through this step until you find the limit.
 - 5: Turn the adjusting rod to the direction of the '+', the roller door will move up bit by bit. You can move it where you like.
 - 6: Please insert the limit adjusting rod (I) into the yellow regulating hole, and observe the direction of the '+' and '-'.
 - 7: Run down the roller door, at meantime, turn the adjusting rod to '-' .if the roller door doesn't stop when get closed to the ground,please run up the roller door until it stops automatically, and run down the door, at meantime, turn the adjusting rod to '-' .You can loop through this step until you find the limit.
 - 8: Turn the adjusting rod to the direction of the '+', the roller door will move down bit by bit. You can move it where you like.
- Tip: 1.OVERHEATING PROTECTION MAY OCCUR DURING DEBUGGING. PLEASE WAIT UNTIL THE TEMPERATURE DROPS TO THE WORKING RANGE (ABOUT 10 MINUTES) BEFORE DEBUGGING.

ROTATE THE ROLLER DOOR WITH THE ROCKER (J) WHEN POWER CUT.

