

BOOM LIFT

OPERATION MANUAL



NOTE:

Before operating the equipment, please read, understand and follow the relevant safety rules and operating instructions in detail. Only trained and authorized personnel are allowed to operate the equipment. This manual should be considered part of the machine and should be kept with the machine at all times. If you have any questions, please contact us in time.

Only the operator can operate this equipment after fully understanding the possible dangers, warnings and precautions during the operation of the equipment, otherwise the operation is not allowed.

Table of contents

1, Introduction.....	3
2, Symbols and hazard pictorial definitions.....	4
3, Personal safety	5
4, Area safety	6
5, Controller.....	12
6, Inspection	13
7, Operation	16
8, Transportation.....	23
9, Maintenance	27

1, Introduction

To owners, users and operators:

Thank you for choosing and using our equipment. Our primary concern is the safety of our users, which requires our joint efforts to achieve better results. This book is an operation and daily maintenance manual for users or operators of Shandong Qiyun Group machines. This manual should be regarded as part of the machine and should always be kept with the machine. If you, as a device user and operator, we feel that you have made a significant contribution to security by complying with the following regulations:

- 1 Comply with employer, workplace and government regulations. .
- 2 Read, understand, and follow the instructions in this and other manuals that come with the machine.
- 3 Carry out safe work practices within reasonable limits.
- 4 Only trained/certified operators should operate this equipment.

Intended Use and Familiarity Manual:

The purpose of this machine is limited to lifting personnel, their tools, and materials to aerial work sites. It is the operator's responsibility to read and understand this familiarization manual before operating the machine.

1. Before operating a mobile elevating work platform, you must receive training.
2. Every authorized, competent and trained person must be familiar with it.
3. Only trained and authorized personnel should operate this machine.
4. It is the operator's responsibility to read, understand and follow the safety rules in the manufacturer's instructions and operator's manual.
5. The operating manual is located in the manual storage box on the platform.



DANGER :

NOTE: Failure to follow the instructions and safety rules in this manual may result in death or serious injury. Do not proceed unless:

1. You have understood and practiced the rules for safe operation of the machine in this operation manual.
 - (1) Avoid dangerous situations: Know and understand the safety rules before proceeding to the next step.
 - (2) Always perform pre-operation inspections.
 - (3) Always perform functional testing before use.
 - (4) Check the workplace.
 - (5) Use the machine only according to its design intent.
2. You have read, understood and followed the manufacturer's instructions and safety rules - safety manual, operator's manual and machine decals.
3. User safety rules and work site regulations should be read, understood and followed.

4. You have read, understood and complied with all applicable government regulations.
5. You have the proper training to operate the machine safely.

Safety sign maintenance

Replace any missing or damaged safety signs. Operators must maintain safety awareness at all times. Use mild soap and water to clean safety signs. Do not use solvent-based cleaners as these may damage safety marking materials.

Hazard classification

The symbols, color codes and symbolic text used on the labels on this machine have the following meanings:



Safety Warning Sign - Used to indicate the potential for personal injury. Follow all safety instructions following this sign to avoid possible personal injury or death.

! 危险

Indicates a hazardous situation which, if not avoided, could result in death or serious injury.

! 警告

Indicates a hazardous situation which, if not avoided, may result in death or serious injury.

! 当心











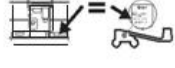

Indicates a hazardous situation which, if not avoided, may result in minor or moderate personal injury.

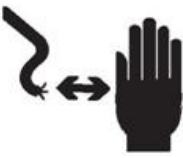
注意

Prompt property damage information.

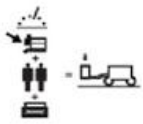
2, Symbols and hazard pictorial definitions

collision risk	collision risk	Electric shock	Explosion hazard	Fall hazard
moving parts	Stay away from the driving	Keep platform stable	Keep clearance	No smoking No fire hazard Stop

Only trained personnel may enter	Platform downhill: 1 Retract the boom. 2 Lower the boom.	Platform uphill: 1 Lower the boom. 2 Retract the boom.	Read manual	Change same model of tyre
				
Read the label on the rated capacity	tipping hazard	tipping hazard	tipping hazard	tipping hazard
				
no touching	lanyard fixed point	wheel load	Electric shock	Read manual
				
The weight of the welding machine reduces the load capacity	Keep away from fire	Explosion hazard. Corrosive acids.	Explosion hazard.	Do not use ether or other high efficiency starting aids in machines equipped with glow plugs

3, Personal safety

personal fall protection

- ✓ Personal Fall Protection Equipment (PFPE) is required when operating this machine.
- ✓ Personnel on the platform must wear safety belts or use safety devices that comply with government regulations. Tie the lanyard to the platform's anchor.
- ✓ Users must comply with user rules, workplace rules and government rules regarding the use of personal protective equipment.
- ✓ All PFPE must comply with applicable government regulations and must be inspected and used according to the PFPE manufacturer's instructions.

4, Area safety

⚠ Electric shock hazard:



This machine is not insulated and does not provide protection against electric shock when in contact with or near electrical wires.

Observe all local and government regulations regarding required clearance from power cords. At a minimum, the required clearances listed in the table below must be observed.

Line voltage	Necessary clearance
0 to 50KV	3.05 m
50 to 200KV	4.60 m
200 to 350KV	6.10 m
350 to 500KV	7.62 m
500 to 750KV	10.67 m
750 to 1000KV	13.72 m

Consider the effects of platform movement, swinging or sagging wires, and be able to withstand strong or gusty winds.



If the machine comes into contact with live wires, stay away from the machine. Personnel on the ground or platform are prohibited from touching or operating the machine before cutting off the power supply.

- Do not operate the machine when lightning or storm.
- Do not use the machine as a ground wire when welding.

⚠ Tip-over hazard

For restricted or unrestricted ranges of motion, personnel, equipment, and materials on the platform must not exceed the platform's maximum capacity.

MODEL NO.	GTBZ-15J
MAX. CAPACITY	230kg
MAX. PASSENGERS	2

If a restricted range of motion is selected for maximum platform capacity, do not move the platform into an unrestricted range of motion area.

Do not exceed the selected maximum platform capacity.

The weight of options and accessories, such as pipe racks and welders, will reduce the rated platform capacity and must be subtracted from the platform capacity. See labels for options and accessories.

If accessories are used, read, understand, and follow the labels and instructions on the accessories.



Raise or extend the boom only when the machine is on solid, flat ground.



Do not use the tilt alarm as a level indicator. The tilt alarm on the platform will sound only if the machine tilts severely.

Use extreme caution if the tilt alarm sounds when the platform is raised. The machine is not level indicator light will illuminate and drive functions will not operate in one or both directions. Determine the condition of the incline boom as shown below and follow these steps to lower the boom before moving the machine to solid, level ground. Never rotate the boom when lowering.

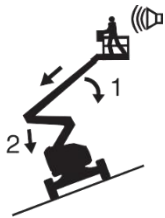

If the tilt alarm sounds when the platform is uphill:

1. Lower the boom.
2. Retract the boom.

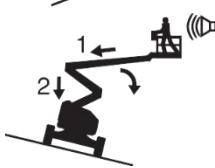

If the tilt alarm sounds when the platform is descending:

1. Retract the boom.
2. Lower the boom.

Do not raise the boom when wind speed may exceed 12.5m/s. If the wind speed exceeds 12.5m/s after the boom is raised, lower the boom and do not continue to operate the machine.



Do not operate the machine during strong or gusty winds. Do not increase the surface area of the platform or load. Increasing the area exposed to wind will reduce the stability of the machine



In the stowed position, use extreme caution and reduce speed when traveling on uneven terrain, gravel, unstable or slippery surfaces, near holes, steep slopes, etc. Do not operate the machine on uneven terrain, unstable surfaces, or other



It is driving in dangerous conditions or near these areas. Do not use the machine as a crane. Do not use the boom to push the machine or other objects. Do not allow the boom to contact adjacent structures. Do not tie the boom or platform to adjacent structural members. Do not place loads outside the perimeter of the platform. Do not push or pull any objects outside the platform. Maximum permissible manual force - CE 400 N

Do not alter or damage any machine parts that may affect safety and stability.
 Do not replace critical parts that affect the stability of the machine with parts of different weights or specifications.
 Do not replace factory-installed tires with tires of a different size or ply rating.
 Do not modify or alter the aerial work platform without the manufacturer's prior written permission.
 Installing additional devices for placing tools or other materials on the platform, toe boards, or guardrails can increase the weight of the platform, increase the surface area of the platform, or increase the load.



Do not place or attach fixed or suspended loads to any part of this machine.



Do not place ladders or scaffolding inside the platform or against any part of the machine.

Only transport tools and materials that are evenly distributed and can be moved safely by people on the platform.

Do not use machine on moving or movable surfaces or vehicles

Make sure the tires are in good condition and the castellated nuts are tight.

⚠ Danger of operating on slopes

Do not drive the machine on a slope that exceeds the machine's maximum uphill, downhill, or side slope rating. Ramp ratings apply only to machine in stowed position.

Maximum Ramp Rating in Stowed Position	
平台下坡	45% (23°)
平台上坡	45% (23°)
侧坡	25% (14°)

NOTE: Ramp ratings are limited by ground conditions and adequate traction when carrying one person inside the platform. Additional platform weight will reduce slope rating. See "Driving on slopes" in the "Operating instructions" section.

⚠ Fall hazard



Personnel on the platform must wear safety belts or use safety devices that comply with government regulations. Tie the lanyard to the platform's anchor.



Do not sit, stand or climb on the platform's guardrails. Stand steadily on the platform floor at all times.



Do not climb off the platform while it is raised.

Keep platform floor free of debris.

Lower the center rail of the platform entrance or close the entrance door before operation.



Do not enter or exit the platform unless the machine is in the stowed position and the platform is at ground level.

⚠ risk of collision

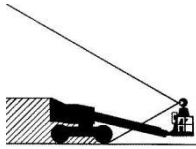

When starting or operating the machine, pay attention to the sight range and blind spots. When spinning the turntable, be careful of the arm position and turntable flick.



Check the work area for overhead obstructions or other possible hazards.



Be aware of the risk of crushing when holding on to the platform guardrail.

Users must comply with user rules and workplace rules regarding the use of personal protective equipment and government rules



The boom can be lowered only when the area below is clear of people and obstacles.



Limit the speed of travel based on ground conditions, congestion, slope, personnel position and any other factors that may cause a collision.



Do not operate the boom on any crane route unless the crane controls are locked, and/or precautions have been taken to prevent any present collision. When operating the machine, do not drive dangerously or perform playful operations.

⚠ Risk of physical injury

- ✓ Always operate the machine in a well-ventilated area to avoid poisoned by carbon monoxide.

-
- ✓ Do not operate the machine when hydraulic oil or air is leaking. Hydraulic fluid leaks or air leaks may penetrate and/or burn the skin.
 - ✓ Incorrect contact with any parts under the cover will result in serious injury. Only trained maintenance personnel should access the compartments. Recommendation: Have the operator carry out servicing only when performing pre-operation inspections. All compartments must remain closed and locked during operation.

⚠ Explosion and fire hazard

- ✓ Do not start the engine if you smell or detect liquefied petroleum gas (LPG), gasoline, diesel or other explosive substances.
- ✓ Do not refuel the machine while the engine is running.
- ✓ Refuel the machine and charge the battery only in an open, well-ventilated area away from sources of ignition such as sparks, flames and lighted cigarettes.
- ✓ Do not use the machine or charge the battery in locations where flammable or explosive gases or particles may be present or where flammable or explosive gases or particles may be present.
- ✓ Do not inject ether into engines equipped with glow plugs.

⚠ Risk of machine damage

- ✓ Do not use damaged or faulty machines.
- ✓ Before each shift, perform a thorough pre-operational inspection of the machine and test all functions. Damaged or faulty machines should be immediately marked and taken out of operation.
- ✓ Ensure that all maintenance operations have been performed as specified in this manual.
- ✓ Ensure all labels are appropriately positioned and easily identifiable.
- ✓ Ensure that the operating manual, safety manual and responsibility manual are intact, legible and kept in the storage box on the machine.

⚠ Risk of component damage

- ✓ Do not use any battery or charger larger than 12V to start the engine.
- ✓ Do not use the machine as a ground wire while welding.
- ✓ Do not use the machine where strong magnetic fields may exist.

⚠ Battery safety

Burn hazard



Batteries contain acidic substances. Wear protective clothing and protective glasses when working with batteries. Avoid spillage or contact with acidic substances in the battery. Use soda and water to neutralize spilled battery acid.

Explosion hazard

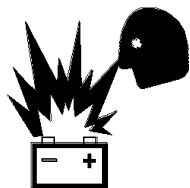

Keep sparks, flames and lighted cigarettes away from batteries. Batteries can release explosive gases.

Electric shock hazard

Avoid touching live terminals.

⚠ Fire hydrant installation safety

All warnings and instructions provided with local fire alarm devices should be read, understood and followed.
Do not exceed the rated load capacity of the platform. The weight of the fire hydrant assembly components reduces the rated capacity of the platform and must be subtracted from the total platform capacity.
Make sure the fire hydrant assembly is securely installed.

⚠ Safe operation of pipe racks

- ✓ All warnings instructions provided with the pipe rack should be read, understood and followed.
- ✓ Do not exceed the rated load capacity of the platform. The weight of pipe rack components and in the pipe rack will reduce the rated capacity of the platform and must be factored into the total platform load capacity.
- ✓ The weight of the pipe rack components and the load within the pipe rack may limit the maximum number of persons that can be accommodated within the platform.
- ✓ Place the load in a central location within the perimeter of the platform.
- ✓ Secure the load to the platform.
- ✓ Do not block the entrance or exit of the platform.
- ✓ Do not obstruct the normal operation of the platform controls or "Emergency Stop" button.
- ✓ Do not operate unless you are properly instructed and understand all hazards associated with moving a platform with an overhanging load.
- ✓ Do not apply horizontal forces or side loads to the platform by raising or lowering a fixed or suspended load.
- ✓ SHOCK HAZARD: Keep pipes away from all live wires. .

⚠ Safe use of welding machine

- ✓ All warnings instructions provided with the welding unit should be read, understood followed.
- ✓ Do not connect welding leads or cables until the welding power unit is turned off from the platform controller.
- ✓ Operation should only be carried out after the welding cables are properly connected and the welding machine is properly grounded.
- ✓ The weight of the welding machine will reduce the rated load capacity of the platform and must therefore be included in the total load capacity of the platform.
- ✓ Only operate the welding machine if the fire extinguisher is immediately ready for use.

Lock after each use

1. Choose a safe parking location, which may be on solid, level ground, free of obstructions and away from heavy traffic.
2. Retract and lower the boom to the stowed position.
3. Turn the turntable until the boom is between the round end wheels.

4. Turn the key switch to the off position and remove the key. Close and lock both side covers to prevent unauthorized use.

5,Controler

A ground control station will be used to raise the platform for storage and functional testing. The ground control station can be activated in an emergency to rescue incapacitated personnel on the platform. When the ground control station is selected, the platform controls, including the emergency shutdown switch, are unavailable.

Ground control panel:

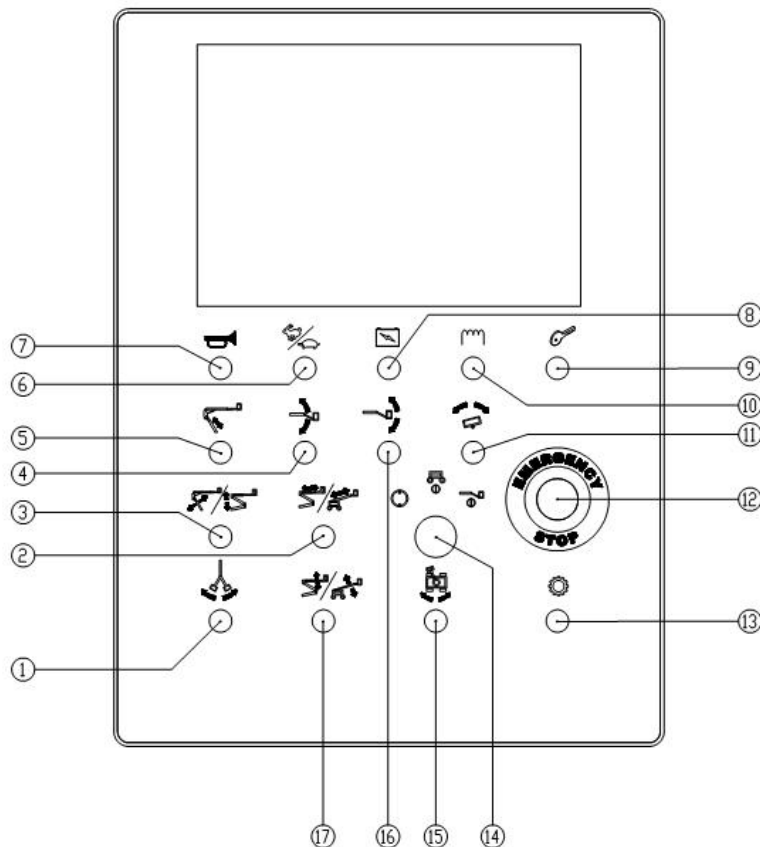

- 1** Feature enable button
Press and hold the function enable button to enable functions on the ground control panel for operation.
- 2** Platform rotary switch
Turn the platform rotation switch to the right and the platform will rotate to the right.
Turn the platform rotation switch to the left, and the platform will rotate to the left.
- 3** Turntable rotation switch
Turn the turntable rotation switch to the right, and the turntable will rotate to the right.
Turn the turntable rotation switch to the left, and the turntable will rotate to the left.
- 4** Boom up/down switch
Turn the boom up/down switch upward and the boom will rise.
Turn the boom up/down switch downward and the boom will lower.
- 5** Jib arm up/down switch
Turn the short arm switch upward and the short arm will rise.
Move the jib arm switch downward and the jib arm will lower.

-
- 6 Engine idle speed (rpm) selector switch
Move the engine idle speed selector switch to the turtle position for low idle speed. Move the engine idle speed selector switch to the rabbit position for low idle speed.
 - 7 horn button
Please sound the horn before operating to remind other people present to pay attention to safety.
 - 8 check engine light
Indicator light on, engine stopped: Tag the machine and remove it from service. The indicator light is on and the engine is still running: please contact service personnel
 - 9 Unused
 - 10 Red "Emergency Stop" button
Push the red Emergency Stop button inward to the off position, stopping all functions and shutting down the engine. Pull the red "Emergency Stop" button to the on position to operate the machine.
 - 11 Boom extend/retract switch
Turn the boom extend/retract switch to the right and the boom will extend.
Turn the boom extend/retract switch to the left and the boom will retract.
 - 12 Keyhole location
 - 13 Feature enable switch
Press and hold the function enable button to enable the function on the ground control panel.
 - 14 Off/Ground/Platform selection requires key switch
Turn the key switch to the off position and the machine will shut down. Turn the key switch to the ground position and the ground controls will operate.
Turn the key switch to the platform position and the platform controls will operate.
 - 15 engine start switch
Press the engine start switch button to start the engine.
 - 16 Unused
 - 17 Platform leveling switch
Pull the platform leveling switch upward and the platform level will rise.
Pull the platform leveling switch downward, and the platform level will drop.

Platform control panel:

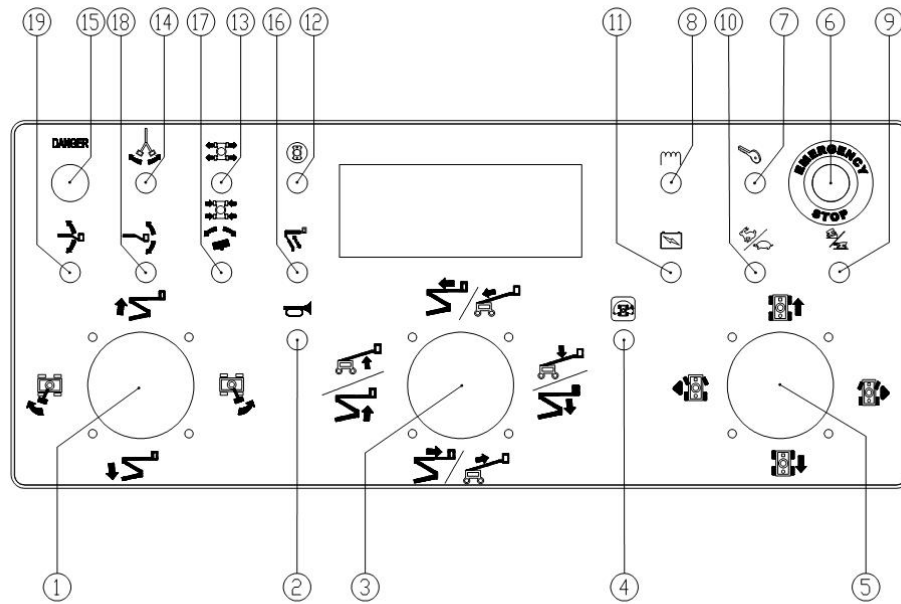

1. Dual-axis proportional control handle for boom up/down and turntable left/right rotation functions
Move the control handle up and the boom will raise.
Move the control handle down and the boom will lower.
Move the control handle to the right and the turntable will rotate to the right.
Move the control handle to the left and the turntable will rotate to the left.
2. Speaker button
Press this button and the horn will sound. Release the button and the horn will stop sounding.
3. Main boom lifting and telescopic
Push the main arm to telescope, pull back the extension arm, raise the arm to the left, and lower the lower arm to the right. .
4. Not used.
5. Start and turn
6. Red "Emergency Stop" button
Push the red Emergency Stop button inward to the off position, stopping all functions and shutting down the engine. Pull the red "Emergency Stop" button to the on position to operate the machine.
7. Engine start switch
Press this switch to start the engine. .
8. Not used.
9. Engine idle speed (rpm) selector switch
Move the engine idle speed selector switch to the turtle position where the foot switch activates low idle speed.
Move the engine idle speed selector switch to the rabbit position where the foot switch activates high idle speed.
10. Tortoise speed position and rabbit position.
11. Check engine light
When the indicator light comes on, the engine stops.
Operating equipment services.
12. Not used.
13. Not used.

14. Not used

15. Warning

16. Telescopic arm function

This switch provides extension and retraction of the telescopic boom and is only operable when the main boom is fully raised.

17. Platform steering switch

Turn the switch to the right and the platform will turn to the right.

Turn the switch to the left and the platform will turn to the left.

18. Platform leveling switch

Pull the platform leveling switch upward and the platform level will rise.

Pull the platform leveling switch downward, and the platform level will drop.

6,Inspection



Do not proceed unless:

- ⚙ You have understood and practiced the rules in this operator's manual for safe machine operation.
- ⚙ 1. Avoid dangerous situations.
- ⚙ 2. Always perform pre-operation inspections.
- ⚙ 3. Always perform pre-use functional testing.
- ⚙ 4. Inspect the workplace.
- ⚙ 5. Use the machine only according to its design intent.

Check basic principles before operation

- It is the operator's responsibility to perform pre-operation inspections and routine maintenance.
- Pre-operation inspection is a visual inspection performed by the operator before each shift. The purpose of the inspection is to detect any obvious problems with the machine before the operator performs functional testing.
- Pre-operation inspections can also be used to determine whether routine maintenance procedures are required. Operators should only perform routine maintenance items as specified in this manual.
- Please review the checklist on the next page and check each item.
- If damage or any unauthorized changes from factory condition are found, the machine should be flagged and stopped to use.
- According to the manufacturer's regulations, only qualified service technicians should service the machine. After repairs are completed, the operator must perform another pre-operation inspection before continuing with functional testing.
- Periodic maintenance inspections should be performed by qualified service technicians in accordance with the manufacturer's regulations and requirements listed in the responsibility manual.

Check before operation

- ✓ Ensure that the operating manual, safety manual, and responsibility manual are intact, legible, and stored in storage bins on the platform.

-
- ✓ Ensure all labels are legible and properly positioned. See the "Check" section.
 - ✓ Check for hydraulic oil leaks and proper oil level. Please refuel as needed. See the "Maintenance" section.
 - ✓ Check for battery fluid leaks and proper oil level. Please add distilled water as needed. See the "Maintenance" section.
 - ✓ Check whether the engine oil is leaking and whether the oil level is appropriate. Please add engine oil as needed. See the "Maintenance" section.
 - ✓ Check for engine coolant leaks and proper coolant level. Please add coolant as needed. See the "Maintenance" section.
 - ✓ Check whether the tire pressure of pneumatic tires is appropriate. Please enter the show and need to inflate it. See the "Maintenance" section.

Inspect the following components or areas for damage, improper installation or missing parts and unauthorized modifications:

- ✓ Electrical components, wiring and cables
- ✓ Hydraulic hoses, connectors, hydraulic cylinders and manifolds
- ✓ Fuel and hydraulic tanks
- ✓ Drive hub of drive motor and turntable motor
- ✓ Wear pads
- ✓ Tires and wheels
- ✓ Engine and related parts
- ✓ Limit switch and horn
- ✓ Siren and indicator lights (if equipped)
- ✓ Nuts, bolts and other fasteners
- ✓ Platform entrance center rail or door
- ✓ Lanyard anchorage point

Check the entire machine for:

- ✓ Cracks in welds or structural components
- ✓ Dents or damage to the machine
- ✓ Severe rust, corrosion or oxidation
- ✓ Ensure that all structural and other critical components are present and that all relevant fasteners and pins are in the correct position and fully tightened.

After completing the inspection, make sure all compartments are properly positioned and locked.

Function check

Basic principles of functional testing:

Functional testing is used to detect faults before starting to use the machine. The operator must follow step-by-step instructions to test all functions of the machine.

Do not use malfunctioning machines. If a malfunction occurs, the machine must be tagged and taken out of service. According to the manufacturer's specifications, only qualified service technicians should service the machine.

After repairs are completed, the operator must perform another pre-operation inspection and functional test before starting to use the machine.

at ground controller

1. Select a solid, level, and hazard-free test area.
2. Turn key switch to ground controls.
3. Pull the red Emergency Stop button out to the on position. Result: The indicator light (if equipped) should flash.
4. Start the engine. See the "Operating Instructions" section.

Test emergency shutdown

5. Push the red Emergency Stop button inward to the off position.
Result: The engine should shut down and no functions should run.
6. Pull the red Emergency Stop button to the on position and restart the engine.

Test machine functionality

16. Do not press and hold the function enable button. Try activating every boom and platform function button.
Result: All boom and platform functions should not operate.
17. Press and hold the function enable button and activate each boom and platform function toggle switch.
Result: All boom and platform functions should run a full cycle. When the boom is lowered, the lowering alarm should sound.

Test the tilt sensor

22. Press the LCD screen control button until degrees appear in the X direction of the turntable level sensor.
Result: The LCD screen should display the angle in degrees.
23. Press the LCD screen control button until degrees appear in the Y direction of the turntable level sensor.
Result: The LCD screen should display the angle in degrees.
24. Press the LCD screen control button until Platform Level Sensor Degrees appears.
Result: The LCD screen should display the angle in degrees.

Emergency shutdown for platform controller testing

-
31. Turn the key switch toward the platform controls.
 32. Push the platform's red Emergency Stop button to the off position.
Result: The engine should shut down and no functions should run.
 33. Pull out the red "Emergency Stop" button and restart the engine.

Test speakers

34. Press the horn button.
Result: The horn should sound.

Test foot switch

36. Push the platform's red "Emergency Stop" button to the OFF position.
37. Pull the red Emergency Stop button to the ON position and do not start the engine.
38. With the foot switch depressed, try starting the engine by moving the starter toggle switch to either side.
Result: The engine will not start
39. Do not depress the foot switch and restart the engine.
Result: The engine should start.
40. Do not depress the foot switch and test the machine's functions.
Result: All functions will not run.

Test machine functionality

41. Depress the foot switch. 3
42. Activate the control handle or toggle switch for each function of the machine.
Result: All boom and platform functions should run a full cycle.

test steering

43. Turn the steering mode selector switch and select steering.
44. Depress the foot switch. 3
45. Slowly move the drive control handle in the direction indicated by the yellow triangle on the control panel;
Result: The square end wheel should turn in the direction indicated by the yellow triangle on the drive chassis.
46. Slowly move the control handle in the direction indicated by the yellow triangle on the control panel;
Result: The square end wheel should turn in the direction indicated by the yellow triangle on the drive chassis.
47. Turn the steering mode selector switch and select steering.
48. Depress the foot switch.
49. Slowly move the control handle in the direction indicated by the yellow triangle on the control panel; or press the thumb rocker switch in the direction indicated by the yellow triangle.
Result: The round end wheel should turn in the direction indicated by the yellow triangle on the drive chassis.

-
50. Slowly move the drive control handle in the direction indicated by the yellow triangle on the control panel;
Result: The round end wheel should turn in the direction indicated by the yellow triangle on the drive chassis.
51. Turn the steering mode selector switch and select winch steering.
52. Depress the foot switch.
53. Slowly move the drive control handle in the direction indicated by the yellow triangle on the control panel; Result: All wheels should rotate in the direction indicated by the blue triangle on the drive chassis.
54. Slowly move the control handle in the direction indicated by the yellow triangle on the control panel;
Result: All wheels should turn in the direction indicated by the yellow triangle on the drive chassis.
55. Turn the steering mode selection switch and select coordinate steering.
56. Depress the foot switch.
57. Slowly move the drive control handle in the direction indicated by the yellow triangle on the control panel;
Result: The square end wheel should turn in the direction indicated by the yellow triangle on the drive chassis. The round end wheel should rotate in the direction indicated by the yellow triangle on the drive chassis.
58. Slowly move the control handle in the direction indicated by the yellow triangle on the control panel;
Result: The square end wheel should turn in the direction indicated by the yellow triangle on the drive chassis. The round end wheel should rotate in the direction indicated by the blue triangle on the drive chassis.

Test drive and brake functions

59. Depress the foot switch.
60. Slowly move the drive control handle in the direction indicated by the yellow arrow on the control panel until the machine begins to move, then return the handle to the center position.
61. Slowly move the control handle in the direction indicated by the red arrow on the control panel until the machine begins to move, then return the handle to the center position.
Result: The machine should move in the direction indicated by the red arrow on the drive chassis, then suddenly stop.
NOTE: The brakes must be able to stop the machine on any grade it is capable of climbing.

Test drive enablement system

62. Depress the foot switch and lower the boom to the stowed position.
63. Rotate the turntable until the boom moves beyond one of the rounded end wheels and the drive enable icon.
Result: The Drive Enable indicator should illuminate at any position of the boom outside of the range shown.
64. Move the drive control handle away from the center position. Result: The driver function should not run.
65. Turn the drive enable toggle switch and slowly move the drive control handle away from the center position.
Result: The driver function should run.

NOTE: When using the drive enable system, the machine can travel in the opposite direction of travel and steering control handle movement. Use the color-coded directional arrows on the platform controls and drive chassis to determine direction of movement.

If the drive control handle does not move within two seconds of turning the drive enable toggle switch, the drive function will not operate

Test limited drive speed

66. Depress the foot switch.
67. Raise the boom 10° above horizontal.
68. Slowly move the drive control handle to the full drive position to the full drive position.

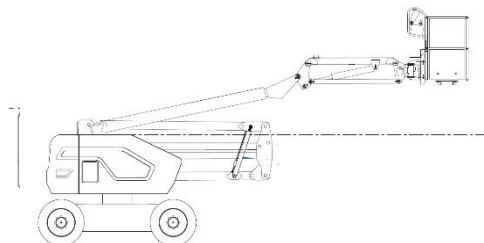

Result: The maximum achievable drive speed of the primary boom in the raised condition should not exceed 18 cm per second.

NOTE: In 68 seconds, the machine will advance 12 m.

69. Lower the boom to the stowed position.
70. Extend the boom 1.2 m.

71. Slowly move the drive control handle to the full drive position.

Result: The maximum achievable drive speed of the primary boom in the raised condition should not exceed 18 cm per second.

NOTE: In 68 seconds, the machine will advance 12 m.

72. Raise the boom 50° above horizontal and extend the boom to its full length.
73. Slowly move the drive control handle to the full drive position.

Result: The maximum achievable drive speed of the boom with the boom fully extended should not exceed 4.5 cm per second.

NOTE: In 270 seconds, the machine will advance 12 m.

Test drive tilt cutout switch

74. Depress the foot switch.
75. With the boom fully retracted, drive the machine along the Y-axis to a slope (front to back) where the chassis angle is greater than 4.5° .

Result: The machine will continue to drive.

76. Return the machine to level ground and extend the boom approximately 91.4 cm.

77. Drive the machine along the Y axis to a slope where the chassis angle is greater than 4.5° (front to back).

Result: When the machine reaches 4.5° of chassis tilt, the machine should be stopped immediately and an alarm should sound at the platform controller.

78. Retract the boom to the stowed position or drive in the opposite direction.

Result: The machine should drive.

79. Return to level ground and raise the boom approximately 15° above horizontal.

80. Drive the machine along the Y-axis to a slope (front to back) where the chassis angle is greater than 4.5° .

Result: When the machine reaches 4.5° of chassis tilt, the machine should be stopped immediately and an alarm should sound at the platform controller.

81. Lower the boom to the stowed position or drive in the opposite direction. Result: The machine should drive.

82. Return to level and retract boom.

83. Depress the foot switch. 2

84. With the boom fully retracted, drive the machine along the X-axis to a slope (side to side) where the chassis angle is greater than 3° .

Result: The machine will continue to drive.

85. Return the machine to level ground and extend the boom approximately 91.4 cm.

86. Drive the machine along the X-axis to a slope (from side to side) where the chassis angle is greater than 3° .

Result: When the machine reaches 3° of chassis tilt, the machine should be stopped immediately and an alarm should sound at the platform controller.

87. Retract the boom to the stowed position or drive in the opposite direction. Result: The machine should drive.

88. Return to level ground and raise the boom approximately 15° above horizontal.

89. Drive the machine along the X-axis to a slope (side to side) where the chassis angle is greater than 3° .

Result: When the machine reaches 3° of chassis tilt, the machine should be stopped immediately and an alarm should sound at the platform controller.

90. Lower the boom to the stowed position or drive in the opposite direction. Result: The machine should drive.

91. Return to level and retract boom.

Test boost/drive selection functionality

96. Depress the foot switch.

97. Move the drive control handle away from the center position and activate the boom function control handle.

Result: All boom functions should not function. The machine will move in the direction indicated on the control panel.

workplace inspection

Workplace inspections help operators determine whether the workplace can support safe machine operation. The operator should do this first before moving the machine to the job site.

It is the operator's responsibility to understand and remember workplace hazards and then to be aware of and avoid them when moving, installing, and operating machinery.

When conducting workplace inspections, be careful and avoid the following dangerous situations:

- Steep slopes or caves
- Protrusions, ground obstructions or debris
- Incline surface
- Unsound or slippery surface
- Aerial obstacles and high-voltage power lines
- Dangerous location
- Surface supports that are insufficient to withstand the full load forces exerted by the machine.
- Wind and weather conditions

-
- Presence of unauthorized persons
 - Other possible unsafe conditions.

7,Operation



Do not proceed unless:

You have understood and practiced the rules in this operator's manual for safe machine operation.

- 1 Avoid dangerous situations.
- 2 Always perform pre-operation checks.
- 3 Always perform pre-use functional testing.
- 4 Inspect the workplace.
- 5 Use the machine only for its design intent.

Basic principles of operation

The Operating Instructions section provides specific instructions for all aspects of machine operation. It is the operator's responsibility to follow all safety rules and instructions in the operator's manual, safety manual and responsibility manual.

It would be unsafe to use this machine for any purpose other than lifting people, their tools, and materials to an aerial workplace.

It's even dangerous.

Only trained and authorized personnel should be allowed to operate this machine.

If more than one operator uses the same machine at different times during the same work shift, they must all be qualified operators and follow all safety rules and instructions in the Operator's Manual, Safety Manual and Responsibilities Manual. This means that every new operator should perform a pre-operation inspection, functional test and workplace inspection before using the machine.

Start the engine

- 1 At the ground controls, turn the key switch to the desired position.
- 2 Make sure both the ground and platform control red Emergency Stop buttons are pulled out to the on position.

Perkins or Yanmar engine

Press the engine start button. The engine start button can be pressed at any time when the ignition plug is on. If the engine fails to start or stalls, the restart delay will disable the starter switch for 5 seconds.



If the engine still does not start successfully after 15 seconds of starting, determine the cause and repair the fault. You should wait 60 seconds before trying to start again.

In low temperature conditions, -6°C and below, the engine should be heated for 5 minutes before operating the machine to prevent damage to the hydraulic system. In extremely low temperature conditions, -18°C and below, the machine should be equipped with the cryogenic start-up kit option. If you attempt to start the engine when the temperature is below -18°C , you may need to use a booster battery.

Emergency shutdown

Push the red "Emergency Stop" button on the ground or platform controller to the off position to stop all functions and shut down the engine.

Repair of any operating function must be performed when the red "Emergency Stop" button is released.

Selecting and operating ground controls will interrupt the functionality of the platform's red "Emergency Stop" button.

Emergency power

If the main power source (engine) fails and the boom cannot be lowered, please use emergency power.

- 1 Turn key switch to ground or platform controls.
- 2 Pull the red Emergency Stop button out to the on position.
- 3 When operating the auxiliary controls from the platform, depress the footswitch.
- 4 Activate the desired function while keeping the auxiliary power switch on.

Note: The drive function should not be operated with emergency power. Emergency power can only lower and retract the boom, but cannot be used to raise the boom or continue working.

Operate from the ground

- 1 Turn key switch to ground controls.
- 2 Pull the red Emergency Stop button out to the on position.
- 3 Start the engine.

Position the platform

- 1 Press and hold the function enable button.
- 2 According to the marks on the control panel, press the corresponding function button.

Use the function speed selection buttons (tortoise and hare) to select the function speed.

When the arrow on the turtle is illuminated, the machine functions as low idle. When the arrow on the rabbit is illuminated, the machine functions as high idle.

Drive and steering functions are not available via ground controls.

Operate from the platform

- 1 Turn the key switch toward the platform controls.
- 2 Pull both the ground and platform red "Emergency Stop" buttons to the on position.
- 3 Start the engine. Do not depress the foot switch when starting the engine.

Adjust platform position

- 1 Press the foot switch.
- 2 Follow the marks on the control panel and slowly move the corresponding function control handle or thumb rocker switch or toggle switch.

Turn

- 1 Press the foot switch.
- 2 Turn the steering mode switch to select the steering mode. The indicator light next to the current steering mode will illuminate.

3 Move the drive/steering control handle slowly in the direction indicated by the yellow triangle. Use the color-coded directional arrows on the platform controls and drive chassis to determine the direction the wheels are turning.

drive

1 Press the foot switch.

2 Increase speed: slowly move the drive/steering control handle in the direction indicated by the red or yellow arrow

Reduce speed: Slowly move the drive control handle so it points to the center position.

Stop: Return the drive/steering control handle to the center position, or release the foot switch. Use the color-coded directional arrows on the platform controls and drive chassis to determine the direction the machine is traveling. The machine's travel speed is limited when the boom is raised or extended.

⚠ driving on slopes

Determine the machine's uphill, downhill, and side slope ratings and grade.



Maximum slope rating, platform downhill
(climbing ability): 45% (24°)



Maximum slope rating, platform uphill:
45% (24°)



Maximum side slope rating: 25% (14°)

Note: Ramp ratings are limited by ground conditions and adequate traction when the platform is carrying one person. Additional platform weight will reduce slope rating. The term gradeability is used only in weighted gradeability configurations.

Make sure the boom is in a horizontal position and the platform is between the round end wheels.

Move the drive speed selector switch to the position where the machine is on the **slope**

Determine the slope:

Measure the slope with a digital inclinometer or follow the steps below.

You need the following tools:

- Carpenter's ruler
- Straight pieces of wood, at least 1 m in length
- Tape measure

Place the block on the slope.

At the end of the drop, place a carpenter's ruler on the upper edge of the block and lift the end of the block until it is level. Keeping the block level, measure the vertical distance from the bottom of the block to the ground.

Divide the tape measure distance (raised height) by the block length (travel) and multiply by 100. For example:

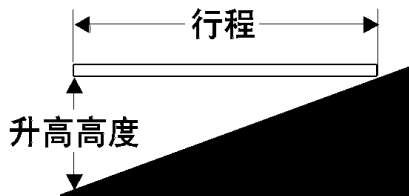

Block = 3.6 m

Travel = 3.6 m

Raised height = 0.3 m

$0.3 \text{ m} \div 3.6 \text{ m} = 0.083 \times 100 = 8.3\% \text{ grade}$

If the slope exceeds the maximum uphill, downhill, or side slope rating, the machine must be lifted or transported up or down the slope. See the Transport and Lifting section.

Engine idle speed selection (rpm)

Press the engine idle speed selector switch to select engine idle speed (rpm).

The indicator light next to the current setting will light up.

- Turtle symbol: low idle
- Rabbit symbol: high idle speed

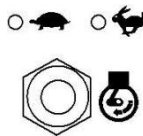

check engine light



Indicator light on, engine stopped: Tag the machine and remove it from service.

The indicator light is on and the engine is still running: contact service personnel.

Using status range indicators

The use status range indicator will illuminate to notify the operator that a function is interrupted and/or operator action is required.

The raise/retract boom indicator light flashes: Raise/retract the boom until the indicator light goes out.

Lower boom indicator light flashes: Lower the boom until the indicator light goes out.

The machine is not level indicator light flashes: When this light flashes, the tilt alarm will

ring. Move the machine to a solid, level surface.



If the tilt alarm sounds when the platform is uphill:

- 1 Lower the boom.
- 2 Retract the boom.

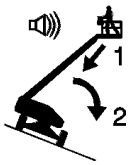

If the tilt alarm sounds when the platform is descending:
1 Retract the boom.
2 Lower the boom.

Platform out-of-level indicator light flashes: The tilt alarm will sound when this light flashes. The platform leveling button switch only works in the direction of keeping the platform level. Level the platform until the pilot light goes out.
Platform overload indicator light

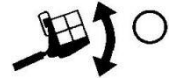

A flashing light indicates the platform is overloaded. The engine will stop working and no functions will work. Remove the load from the platform until the indicator light goes out, then restart the engine.

8, Transportation



Comply and obey:

- ⚙ The driver is solely responsible for ensuring that the machine is properly secured and that the correct trailer is selected in accordance with other local MOC regulations and company policy.
- ⚙ Qualified freight forwarding companies with expertise in preparing, loading, and securing containers and lifting equipment should be sought.
- ⚙ Only qualified lifting operators should load and unload the machine.
- ⚙ Transport vehicles must be parked on level ground.
- ⚙ When loading the machine, the transport vehicle must be secured to prevent rolling.
- ⚙ Ensure vehicle capacity, loading surface, chains or belts are sufficient to support the weight of the machine.
- ⚙ Do not drive the machine on a slope that exceeds the machine's uphill, downhill, or incline rating. See "Driving on slopes" in the "Operating instructions" section.

Ensure truck or trailer transportation is safe

The turntable rotation latch should be used every time the machine is transported.

Before transporting, turn the key switch to the OFF position and remove the key. Check the machine thoroughly for loose or unsecured parts.

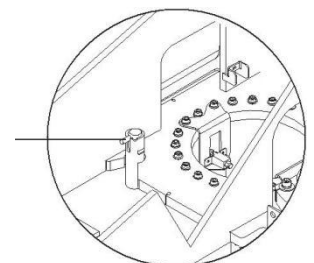

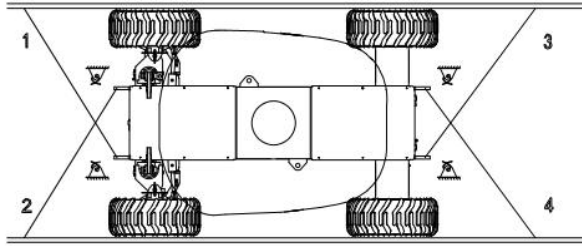

fixed platform

Lower the platform as low as possible so that the jib arm and platform can be folded under the boom. Thread the belt through the platform bracket between the boards next to the spinner. Secure the straps to each corner of the truck body.

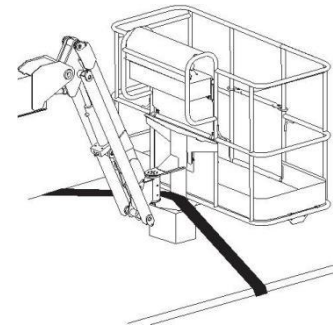

Hoisting

Comply and obey:

- ⚙ Only qualified riggers should assemble rigging and lift the machine.
- ⚙ Make sure the crane lifting capacity, loading surface, straps or ropes are sufficient to support the weight of the machine. See nameplate for machine weight.

Lifting instructions

Fully lower and retract the boom. Remove any loose parts from the machine. Use the turntable rotation lock to secure the turntable.

Only attach rigging to designated lifting points on the machine.

Adjust rigging to avoid damage to machine and keep machine level.

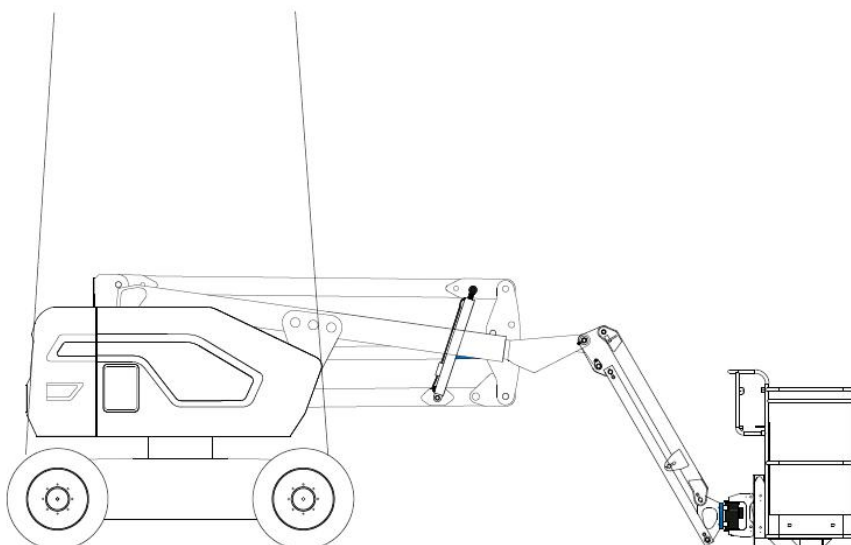

9, Maintenance

Comply and obey:

- ⚙ Operators should only perform routine maintenance items as specified in this manual.
- ⚙ Periodic maintenance inspections should be completed by qualified service technicians in accordance with the manufacturer's regulations and requirements established in the responsibility manual.
- ⚙ Dispose of materials in accordance with government regulations.
- ⚙ Only use replacement parts approved by Shandong Qiyun Group.

Maintain symbol legend

This manual uses the following symbols to help express relevant meanings in the instructions for use. When one or more symbols appear in front of a maintenance program, the meaning is as follows.



Indicates that tools are required to perform this procedure.



Indicates that new parts are required to perform this procedure.



Indicates that the engine must be cooled down before performing this procedure.

Check engine oil level



Maintaining proper engine oil levels is critical to maintaining good engine performance and service life. Operating the machine without the proper oil level can damage engine components.

NOTE: Check the oil level with the engine off.

1 Check the oil level gauge. Add oil as needed. .

Perkins 404D-22T

Oil type	15W-40
----------	--------

Oil Type - Low Temperature Conditions	5W-40
---------------------------------------	-------

Check hydraulic oil level



Maintaining the proper hydraulic oil level is critical to machine operation. If the hydraulic oil is at an inappropriate level, it can damage hydraulic components. Through routine inspections, inspectors can identify changes in hydraulic oil levels that can indicate problems with the hydraulic system.

-
- 1 Make sure the boom is stowed.
 - 2 Visually inspect the oil level gauge located on the side of the hydraulic tank.
Result: The hydraulic oil level should be within the upper 5cm of the oil level gauge.
 - 3 Add oil as needed. Never add too much.

Check engine coolant level—coolant model



Maintaining the proper engine coolant level is critical to the longevity of your engine. Improper coolant levels will affect the engine's cooling capabilities and damage engine components. Through routine inspections, inspectors can identify changes in coolant levels that can indicate problems with the cooling system.

- ▲ Risk of burns. Never remove the radiator cap while the engine is running. Contact with pressurized coolant may cause severe burns. Wait until the engine has cooled down before removing the radiator cap.

- 1 Check the level in the coolant recovery tank. Add coolant as needed.

Result: The fluid level should be visible at the FULL mark on the hydraulic tank or in the oil level gauge.

Check battery



Good battery condition is critical to proper machine performance and safe operation. Improper electrolyte levels or damaged cables and wiring can cause component damage and hazardous situations.

- ▲ Motor danger. Contact with live circuits may result in death or serious injury. Remove all rings, watches, and other jewelry.

- ▲ Risk of bodily injury. Batteries contain acidic substances. Avoid spillage or contact with acidic substances in the battery. Use soda and water to neutralize spilled battery acid.

- 1 Put on protective clothing and safety glasses.
- 2 Make sure the battery cable connections are secure and not corroded.
- 3 Make sure the battery locking bracket is properly positioned and secure.

NOTE: Adding terminal protectors and corrosion-resistant sealants can help eliminate corrosion on battery terminals and cables.

Check bolts and stop pins



Regularly check whether the bolts and stop pins on the machine are loose.

Regular maintenance

Quarterly, annual, and biannual maintenance items must be completed by personnel trained and qualified in the maintenance of this machine, according to the procedures in this machine's service manual.

product specifications

MODEL NO.	GTBZ-15J
MAX. working height	16.6 m
MAX. platform height	14.6 m
MAX. horizontal extension	8.52 m
Loading capacity	230KG
Gradeability	45%
Outer turning radius	4.8 m
Inner turning radius	1.8 m
Driving speed (stowed state)	6.3KM/H
Driving speed (raised state)	1.1KM/H
Turntable rotation angle	360°
Platform rotation angle	±80°
Maximum wind speed allowed for work	12.5m/s
Maximum allowable lateral force	400N
Maximum allowable tilt angle	5°
Length of the entire vehicle (in closed state)	7.7 m
Vehicle width (vehicle closed state)	2.28 m
Vehicle height (vehicle closed state)	2.18 m

Ground clearance	0.3 m
Wheelbase	2.02 m
Platform size	1.53*0.77 m
Tire model	33*12
Engine	Yanmar/Perkins
Fuel tank volume	110L
Hydraulic tank volume	180L
Control voltage	12V
Drive and steering	4*4*2
Vehicle weight	7800kg

Maintenance schedule

There are five types of maintenance inspections that must be performed according to a schedule: daily, quarterly, every six months, annually, and every two years. Taking into account the repetitive procedures "Periodic Maintenance Section" and "Maintenance Inspection Report" are divided into five sub-sections - A, B, C, D and E. Use the table below to determine the combination of procedures required to perform scheduled maintenance.

Maintenance interval	Maintenance procedures
Every day or every 8 hours	A
Quarterly or every 250 hours	A+B
Every six months or every 500 hours	A+B+C
per year or every 1000 hours	A+B+C+D
Every two years or every 2000 hours	A+B+C+D+E

Maintenance inspection report

The maintenance report contains inspection items for each type of periodic inspection. Keep completed forms for more than three years.

Maintenance record sheet

Model NO.	
Devise serial number	
Production Date	
User	
Maintainer's signature	
Maintainer position	
Maintainer unit	

Follow the steps in this chapter to check the maintenance procedures one by one. Record the results. If any result is N, the equipment must be taken out of service and re-inspected after repair and noted R.

Note:

A- YES, the machine is in good condition. N-No, the machine is faulty. R-Repaired, the machine has been repaired.

Record Form A			
Items	Y	N	R
A-1 Manual			
A-2 Label			
A-3 Check before operation			
A-4 Function check			
A-5 Engine maintenance			

A-6 Security system			
Executed every 40 hours			
A-7 engine air filter			
New car work will be performed after 40 hours			
A-8 Performing 30-day maintenance			
New car work will be performed after 50 hours			
A-9 Engine Maintenance			
Execute every 50 hours			
A-10 Engine Maintenance			
Executed every 100 hours			
A-11 Engine Maintenance			
Executed every 150 hours			
A-12 reducer gear oil			
Executed every 200 hours			
A-13 Engine Maintenance			
A-14 engine oil water separator			
Performed every 1-2 months			
A-15 engine maintenance			

Record Form B			
Items	Y	N	R
B-1 Battery			

B-2 Wiring harness			
B-3 Wheels and tires			
B-4 Key switch			
B-5 Emergency stop switch			
B-6 Speaker			
B-7 Brake			
B-8 Driving speed (car closing state)			
B-9 Travel speed (extended state)			
B-10 Hydraulic tank filter element			
B-11 Hydraulic oil analysis			
B-12 Warning Light			
B-13 Reducer gear oil			
Execute every 400 hours			
B-14 Engine maintenance			

Record Form C			
Items	Y	N	R
C-1 Platform overload system			
C-2 Emergency descent system			
C-3 Fuel tank			
C-4 Hydraulic tank filter			
Execute every 500 hours			

C-5 Engine maintenance			
Executed every 800 hours			
C-6 Engine maintenance			

Record Form D			
Items	Y	N	R
D-1 Each movable pin			
D-2 Slider			
D-3 Hydraulic oil return filter			
D-4 Engine maintenance			
D-5 Reducer gear oil			
Execute every 1500 hours			
D-6 Engine maintenance			

Record FormE			
Items	Y	N	R
E-1 Check and replace hydraulic oil			
Execute every 2000 hours			
E-2 Engine maintenance			
Execute every 3000 hours			
E-3 Engine maintenance			