Manual Book

Thanks for your attention to our excavators!
To know more about our excavators, please read the handbook carefully.



Directory

☆Chapter 1	Operation instruction.....	3
☆Chapter 2	Important Notes.....	13
☆Chapter 3	How to Drive and Operate.....	19
☆Chapter 4	Safe Operating.....	23
☆Chapter 5	Transportation and Parking.....	39
☆Chapter 6	Operate and Control notes.....	42
☆Chapter 7	Main Structure characters of excavator.....	48
☆Chapter 8	Maintenance and Repair.....	49
☆Chapter 9	Common faults and trouble shooting.....	59
☆Appendix	Drawing of Oil filling Drain of Speed reducer.....	62

Chapter 1 Operation Instruction

●Operation joystick lock

This device is to lock/unlock operation joystick. Please operate exactly according to instruction label on machine.

Note

- 1.This device could not lock traveling joystick and extra line foot valve. They still work when the lock joystick is pulled up.
- 2.When the lock joystick is pulled up, you cannot operate the working device (working device includes boom, arm and bucket).
- 3.Please fully pull up the lock joystick before you are on or off the machine. Please lower the bucket down to ground and shut down the engine before you left.

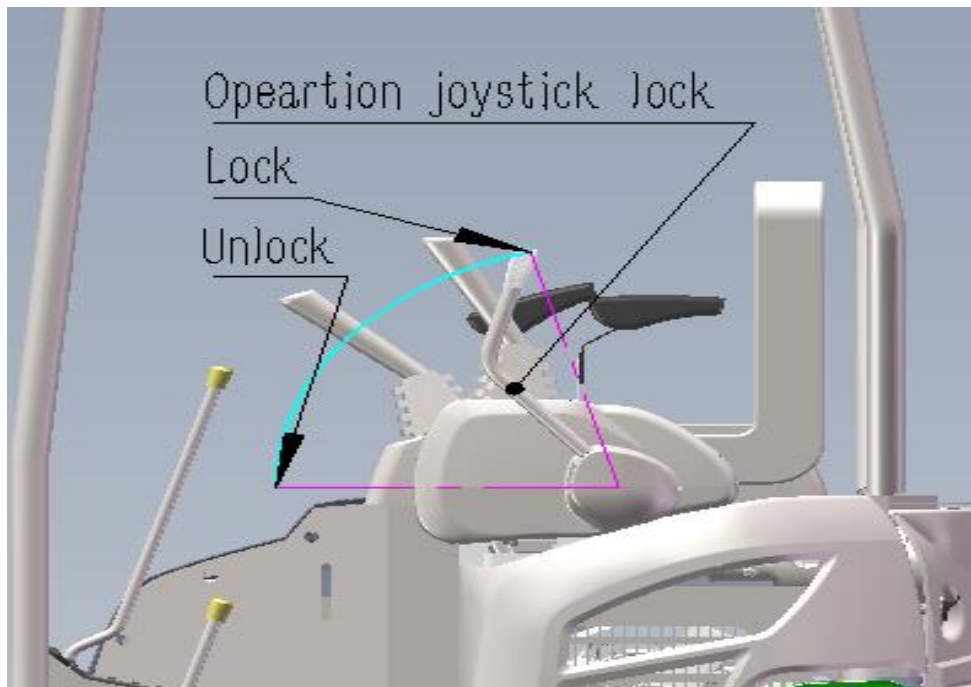

⚠ CAUTION

Before you pull over or left machine, please do lower the bucket down to ground and pull up the lock joystick, otherwise it is dangerous if the working device falling down. Please make sure the lock joystick is at locked position, shut down the engine and pull out the keys.

Operation iovstick instruction



- **Starting engine**

- Rotation the start key by clockwise to start the engine.**

- **Accelerator**

- 1、 Pull backward the accelerator joystick to increase engine rotate speed.

-
- 2、 Push forward the accelerator joystick to decrease engine rotate speed.
 - 3、 Before you shut down engine, push forward the accelerator joystick to the bottom slowly, decrease engine rotate speed gradually,

- **Flame out**

Rotation the start key anti-clockwise to shut off the engine

- **Traveling joystick**

⚠ CAUTION

If you move dozer blade on behind and operate the traveling joystick, machine will travel to the opposite direction of your operation. Thus, please confirm the direction of dozer blade before you travel the machine. Failure on confirmation may make the machine travel to opposite direction and cause injury or accident.

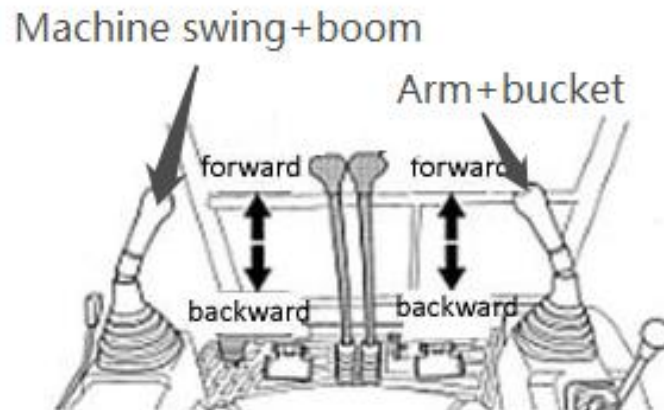

When the dozer blade is on front, push traveling joystick forward will make machine travel forward, pull traveling joystick backward will make machine travel backward.

- **operation joystick**

operation joystick is to operate boom, arm, bucket, machine swing or boom deflection.

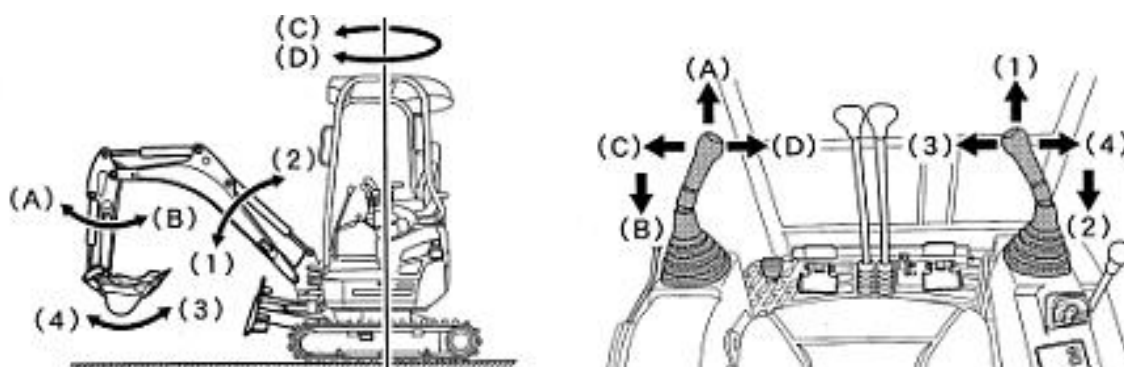

Operation direction	Left operation joystick
A	斗杆下降
B	斗杆上升
C	左回转
D	右回转

Operation direction	Right operation joystick
1	动臂上升
2	动臂下降
3	挖斗挖掘
4	挖斗卸载

⚠ CAUTION

Please do not swing or deflection machine on slant road, otherwise there might be danger of turnover. If you have to do this on slant road, please make your machine's position flat then proceed.

Note

1、The machine is using hydraulic pilot system, so work device could be operated only when engine is running. If you need bucket touch the

ground, please switch engine to low speed then proceed.

2、 Before you go on or off the machine, please pull up the lock joystick of pilot handle and make sure it's in lock position

3、 If hydraulic oil's temperature is low, the responsiveness of working device joystick will be slow, so please warm up the machine before work.

4. Please following below procedures before dismounting hydraulic attachments:

(1) Lower engine rotate speed, lay down the bucket on the ground ;

(2) Shut down the engine, move both sides working device joysticks to all directions;

(3) Wait at least 10 minutes to release pressure in hydraulic circuit.

Do not ignore any above procedure to avoid dangerous.

5. Do not come close to the machine before working device touch the ground.

Important

1、 Boom operation

Please avoid bucket tooth hooking on dozer blade when boom going down.

2、 Arm operation

When stretch out the arm, if the arm is vertical to the ground there might be momentary movement pause, this is not malfunction please do not worry about that.

3、 Fast swing or deflection will short machine using life, please don't operate like that.

●工作装置偏转实现

当我们需要偏转动臂时，按住左工作手柄的中心部分，然后左右摆动手柄，动臂随之左右偏转

Boom swing to left



Boom swing to right

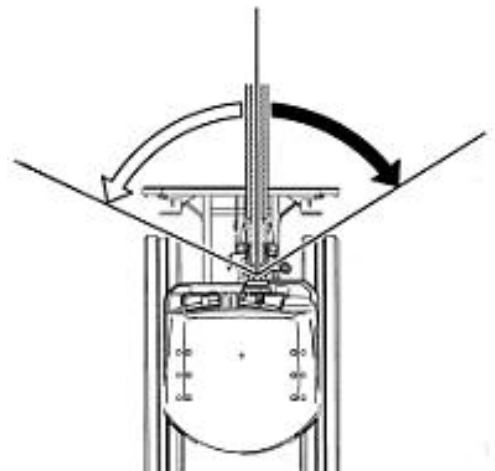

⚠ CAUTION

**When work with boom deflection, keep people or barrier
away
boom deflection range to avoid injury.**

●Dozer blade joystick

To lift or lower dozer blade

Push the joystick forward to lower dozer blade, pull the joystick backward to lift dozer blade.

当我们需要休息的时候，可以用双手或者单手同时操纵推土铲和前进后退

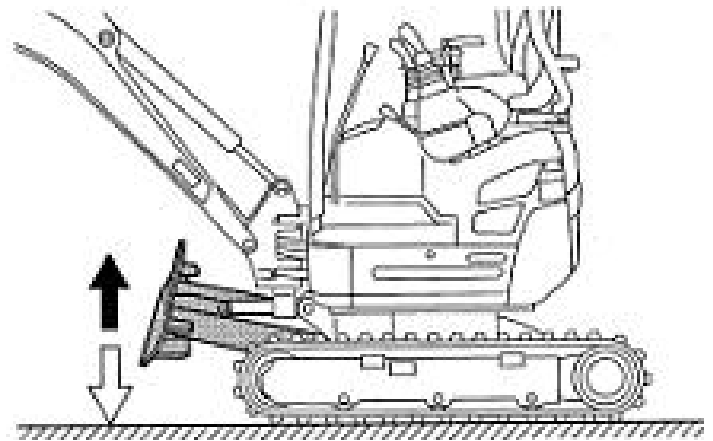
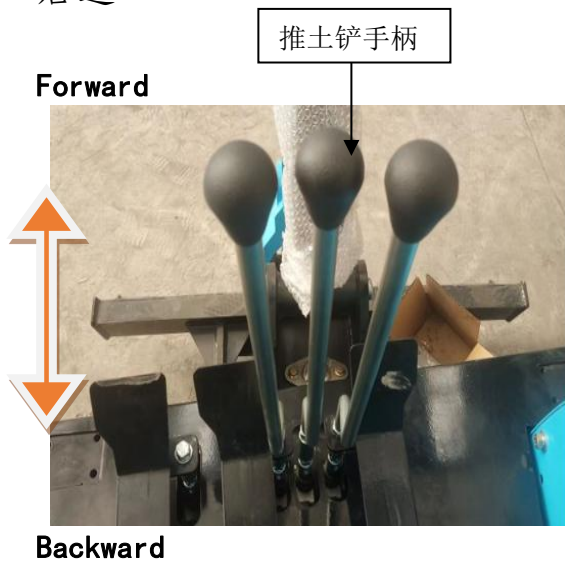

●Safety belt

▲ CAUTION

Please fasten your safety belt before you operate the machine, please adjust the seat to best position and buckle up the safety belt.

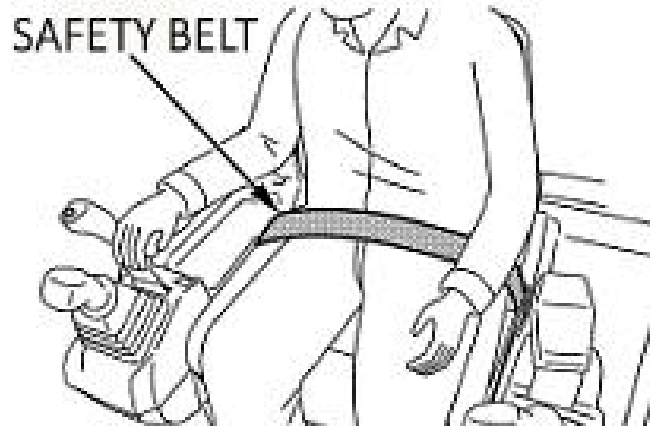

●Seat adjustment

The seat can slide to forward and backward

- 1、 Pull joystick to right side to move seat forward or backward, adjust the seat to the position that easy to operate and confirm the seat is fixed well.
- 2、 Before you put down the seat forward, please put operation joystick lock to “lock” position, shut down the engine then proceed



向上拉住操纵杆可以前后移动座椅，放下操纵杆固定座椅



●Starter

Open the battery power, insert key into starter, turn the key anticlockwise to first gear, engine is preheated. Turn the key clockwise to middle position, then turn the key clockwise to start the engine, Please remove your hand off the key after engine is started.

Important

If the key is attached with metal key chain, it will hinder the signal transmission between key and switch to cause engine start failure.

●Horn

When the key is on running position, press the horn switch and the horn will ring.

●Work lamp/front lamp switch

When the key is on running position, press the work lamp/ front lamp switch, the work lamp/front lamp will be turned on.

●Gauge

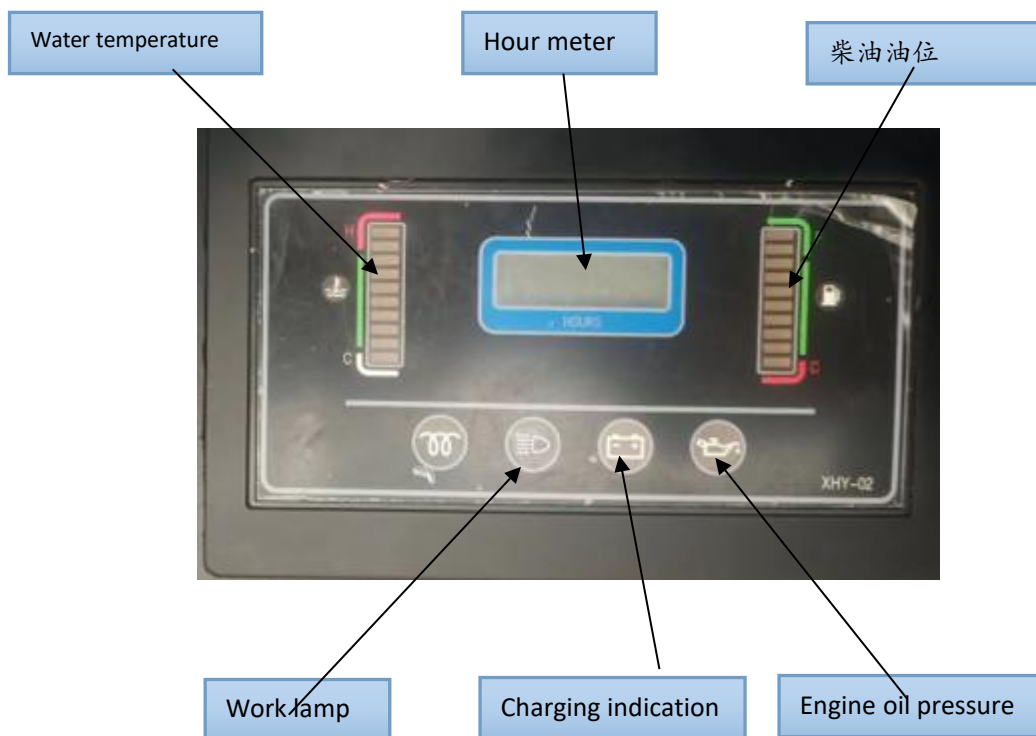

◆Charging indication

When charging system failure occur during engine running, the charging indication light will be turned on. When engine is stopped, put the key to running position the light will be turned on, and will go off after engine is started.

◆Engine oil pressure

When lubricating system failure occur during engine running, the engine oil pressure indication light will be turned on. When engine is stopped, put the key to running position the light will be turned on, and will go off after engine is started. If the light is still on after engine is started, please stop engine and check engine oil level.

◆ Hour meter

Indicate machine's accumulate running hours.

Hour meter's count method: the number will increase 1 every one hour, this is electrical hour meter, so as long as the key is on running position, the meter still counts even the engine is stopped.

Note

Sometimes there might be fog inside hour meter, this is not failure and the fog will disappear after steam evaporation

◆ Water temperature

When water temperature in cooling system reach to 102°C during engine running, water temperature indication light will be turned on for warning. put the key to running position the light will be turned on, when engine is running it will display water temperature

◆ Battery indication

Battery indication light will be turned on after battery charging is finished. Put the key to running position the light will be turned on

◆ Work lamp/front lamp indication

Put the key to running position and press work lamp/front lamp switch, the indication light will be turned on.

Chapter 2: Important Notes

Please read and grasp the notes of the manual book and all the marks on the machine.

If operate and maintenance the machine mistakenly, accident even fatal accident may occur.

If ignore the preparation before working and the Security Rules then accidents happened. Therefore, in order to avoid this kind of accident, we should pay special attention to the rules!

It is dangerous when you operate maintenance mistakenly, so, please check the manual book carefully and confirm you have grasped the contents before the work.

Please be careful when you operate, check and maintenance the excavators, and keep safety in mind. Please pay attention to the safety mark. 

The mark appears in this manual book, which has the three meanings. Please check the explanations as follows:

◆ Danger  Danger is approaching.

If don't avoid the dangers situation, it may cause deaths or other painful damage.

◆ Warning  Temporary dangerous situation. If don't avoid the dangers situation, it may cause deaths or other painful damage .If don't follow the rules, it may lead to the excavator damaged.

◆ Attention  Temporary dangerous situation. Please make maintenance according to the rules what "HT" made. Therefore, you can keep your machine in good condition.

We can't expect all the dangerous items when operating,whatever,it can keep you safety when do anything according to the advice of factory.

Please concentrate on operating to avoid the accidents and any damages of the machine.

Please don't stop studying the manual book until you control all the points.

As for the appropriate maintenance and the repair details, which have been mentioned in the relevant chapters of this manual book?

False maintenance and repair step are very dangerous, which may cause the injuries or deaths. Please check the relevant chapters before making any maintenance and repair.

Please don't touch and operate the machine before you got the points of the manual. Because false maintenance and repair may cause the injuries or deaths.

Maintenance man or the technician may be not very familiar with all the systems of excavator, so it is very necessary for them to master the relevant skills from the manual book. For example, you can find the size and the weight of the parts of the machine, the serviceman can find some suitable data, then, they can confirm if it is necessary to find the lifting appliance or not when they unload the parts.

The basic items as follows should be attention:

1. Please check all the marks of warning, notification, signs.
2. When you knock any parts of the machine, such as rock breaker or other attached parts, or working near the machine, please wear the protective glasses, protective shoes. When doing welding work, please wear the welding gloves, protective gloves, protective apron and other protective clothes. Please don't wear loose or outworn clothes. When you work on the machine, please take out all the rings you are wearing.
3. Please take apart cathode line of the battery before repairing the machine, and hang "No Operating" on the cabin of the excavator.
4. Please put the machine on plain, hard ground when you repair the machine. And also, keep the machine fixed, not moving when repairing above or under the machine.
5. Please don't work on the excavator if hanged by the machine without any fixing

methods.

6. Please release the pressure (such as the air, engine oil, water cooling system etc.) before taking apart of any pipeline, end cap or other relevant parts.

7. Please get the bucket or other working equipment down the ground before you want doing anything on the machine. If it is difficult to lower the bucket or other working equipment, please confirm if it has been fixed to avoid dropping by accident.

8. Please use the step, railing, and footpath. Please clean the places mentioned before using. And, keep right action for the step or the foot path. If the attached equipment damaged, please prepare other ladders, scaffold or working platform in order to avoid any accident.

9. In order to avoid waist hurt, please choose the lifting appliance if the parts over 23kg, and check all the chains, lifting hooks are ok.

10. Care the hot parts to avoid the scald.

11. Please be careful when you take apart the cover board. Take the last two bolts or nut caps slowly. And pay attention to the springs or other stressful parts.

12. Please be careful when you open the radiator cap, oil filter cap or other end caps. For example, to avoid the stressful fluid spouting, because it is very dangerous.

13. Please confirm the tools at good condition. And you should know the use of tools very well before working.

14. When re-install the same retaining clip, please don't choose defective products.

15. Please take some reference data when you doing welding work. And the skilled worker should have enough training and reference knowledge.

16. Please don't damage the electric wire when dismantle or re-install the parts. And don't touch the liquid when you connect to electric wires.

17. Please confirm all the protective equipment installed. Please pay more attention to

the safety when take the protective parts away.

18. Please fix the arm and keep the bucket down the ground when you maintenance and repair the machine.

19. It is very dangerous for loose or damaged fuel pipe, oil pump, and hydraulic pipe. So, Please wear jack but loose and worn-out clothes, because hydraulic oil will cause fire. Don't fold or knock the hydraulic oil pipe, and please don't use the broken oil pipe. Please don't check the leak by hand, because it may injure somebody because of spouting of the hydraulic oil from the invisible pinhole. Please check the leaking by scrip and splint.

20. Please screw down all the oil pipe joints by the suitable torque spanner. Be ensure all the thermal baffle, pipe clamp, protecting cover are in safe. Please try to avoid overheat, shake or the friction with other parts when you are operating.

21. Please stop any operating of the machine, when meet any damaged of the rotator parts or relevant parts.

22. Please pay more attention when you repair or take apart the crawler machine, because the bolts or the splinters may flout when you assemble or disassemble. When you the crawler shoes apart, please put the hold back at the front and the back of the machine to prevent moving by accident.

23. Please pay special attention to the asbestos fiber, because it is harmful to your health if you breathe in this kind of dust. If you find the asbestos fiber, please pay attention to these notes as follows:

A. Don't use compressed air cleaner tools.

B. Avoid brushing and polishing the asbestos fiber material.

C. Clean by wet method, or the vacuum equipment of highly active air, trap valve method.

D. If you work for a long time, please use the discharge fan.

E. If there is no effective method of controlling dust, please wear the face guard.

F. Please comply with the rules of the working place.

G. Please deal with the waste of the asbestos fiber according to the environmental protection law.

H. Please avoid the area of the asbestos fiber, especially the air with asbestos fiber.

Mark board Attached

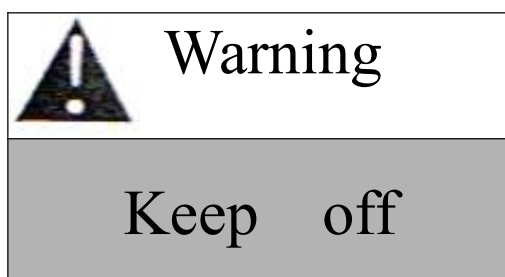

	Warning
No Person	

Chapter 3: Safe Driving and Operating

★Safe notes of excavators

1. The person without training or the operating license is not allowed to drive the machine! And the operator should wear the safety cap and the safety spectacles.
2. The driver should read the <Operation and Maintenance Book>and remember the characters of the structure of “HT” brand excavator.
3. The excavator can be used after the break-in according to the break-in period.
4. Please start the engine strictly according to the manual of engine
5. Please pay attention to the safety of the people and things in 10 meters when the engine starting and working.
6. Confirm the lighting paraphernalia in good condition when working at night.
7. The driver should pay attention to the safety and comply with traffic regulations.
8. Please pay attention to check the meter and the working condition, and listen to the noise. If there is something aberrant, please stop to check and debug the machine.
9. If excavator is down by stern or badly slopes in the process of excavating, please put the bucket down and dump the material to avoid turning over
10. Please keep the joy sticks in the lap position, bucket down the ground to prevent the machine moving by itself or rolling by shocked.
11. Please release the water of the engine at idle speed to prevent frozen the machine when you finish working in winter below 0°C.
12. If it is without control of the engine swing, please stop rapidly, cut off the oil line, and check the machine.
13. Don't fold and knock high pressure oil pipe. Hydraulic oil is about 70°C when the excavator is working, so please keep your body off to avoid scald. Please stop and wait the

oil cooler when repair the hydraulic system. And pay attention to the safety as well.

★★Notes of the excavating in run-in period

1. The engine, speed down 30%, and load down 20%-30%.
2. Prohibit increase the throttle for a long time when starting the engine.
3. It should take about 20-50 seconds to warm-up before starting the engine slowly.
4. Please excavate the loose earth in the former 30-50 hours of the run-in period, and the load is 1/2 of the bucket capacity. As for the last 70-50 hours, you can load more, but less 3/4 of the bucket capacity, and low down the operating speed.
5. Please check, adjust and lubricate the parts of the excavator after the break-in period.

At the same time, check the clean condition of the lubricating oil of the gear box and the hydraulic oil of the hydraulic oil tank, if necessary, change it.

★★★Notes of excavating:

1. Please keep the machine steady on the ground before excavating. In order to achieve the max efficiency. Please control the overload relief to prevent hydraulic oil heater and damage the parts of the machine.
2. Please control the joysticks more slowly.
3. Please change the hydraulic oil filter after about 1200 hours working.
4. Please choose 32# or 46# anti-wear hydraulic oil in winter, and 100# anti-wear hydraulic oil in summer, and the temperature should within 80°C to make the machine work at good condition.
5. When work in winter, please start the engine about 15-20 minutes until the temperature of the hydraulic oil above 10°C, then, start excavating. Or, it will damage the parts and the sealing elements.
6. Please oiling enough at all the pin roll, joint parts, and swing support of the whole

machine after about 6-8 hours working.

7. Please check the gear sectional of the speed reducer regularly, if find lack of oil, please oiling immediately.

8. The bucket should excavate according to the track of cutting, but, don't nibble the hard earth to avoid damage the hydraulic system. Overload-overflow will cause the hydraulic oil heat and damage the sealing elements and oil pipes.

9. Don't swing before the bucket still on ground. It is allowed to process and land formation by bucket, but the side by the swing force.

★★★★The management of excavator oil.

1. The selection of excavator oil

Parts	Outside Temperature°C	Types	Oil Drain Intervals(h)	Replace volume(L)
Engine Oil Pan	-35~20	CD SAE 5W-30	250	Check engine introduction letter
	-20~10	CD SAE 10W		
	-20~40	CD SAE 10W-30		
	-15~50	CD SAE 15W-40		
	0~40	CD SAE 30		
Swing Box	-20~40	CD SAE 30	1000	Check the attached drawing, oiling-draining of the travel speed reducer
Travel Speed Reducer		CD SAE 30		
Hydraulic oil tank		-20~40	CD SAE 10W	5000
	CD SAE 10W-30			
	CD SAE 15W-40			

2. The management of the lubricant grease

We can reduce the abrasion of the moving surface by lubricant (grease) to avoid the noise. Please don't fix any dust, sand, water or other impurity in storage of the lubricant grease.

We recommend the G2-L1 lithium base grease. G2-L1 model are of good anti-wearing. It

is suitable for heavy working.

Please force out the old oil and clean to prevent the sand mixing when oiling. We should select suitable lubricant grease according to different environment temperature:

Lubricant viscosity types and usage temperature relationship

Viscosity type	Usage Temperature T/°C
40	0~40
30	-5~30
15W/40	-20~40
10W/30	-25~30
5W/30	-30~30
5W/20	-40~20

3. The management of other oil

It is including engine oil, hydraulic oil, gear oil etc. We don't mix the oil of different types and grades.

Different kinds of excavator oil have different chemical and physical usages in the working of the machine.

Please confirm the purity of the oil and prevent the mixed sundries (water, dust, sand etc). Select the suitable oil type according to the environment temperature and the usage. If the temperature is low; please select the high viscosity oil, if temperature is high, then, select the low viscosity oil. The gear oil is of high viscosity, it is suitable for heavy duty drive. And the hydraulic oil is of low viscosity, it is suitable for reducing the resistance of the fluid flowing.

Chapter 4: Safety

There are many accidents in the operating and excavating because of the overlook of the basic notes. We will introduce some notes that your should pay attention to as follows. By this way, we can prevent some injuries .Of course, please grasp all the safety notes before operating the machine

Notes before Operating

●Pay attention to the safety rules

Please comply with the safety rules, attention notes etc.Such as, please ask the person who working in the same area to pay special attention to the the warning.



●Wear protected clothes

Please wear suitable and fitted safety shoes, safety cap and working clothes. If necessary, please wear safety spectacle, protected veil, gloves and other labor protection appliances.

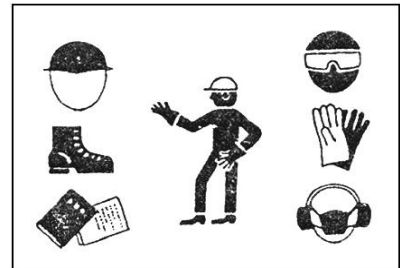

●Please read this operation book carefully.

In order to work more efficiency and more safety, please read this operation introduction carefully before driving. And put the book in the pocket of the seat!

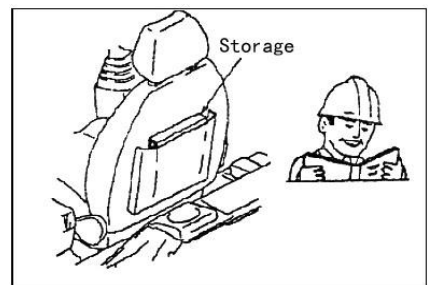

●Don't remodel the machine without any permit ion

Please don't remodel the machine without any permission of "HT"factory and"HT"agent.Or,"HT" company is not responsible for the accidents.

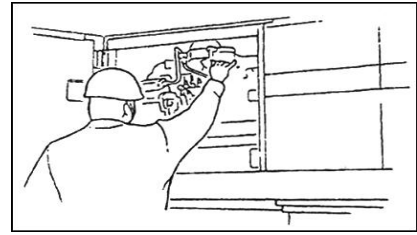

●Prepare emergency store (Option)

Please prepare the fire extinguisher and first-aid kit at any time for the fire or accidents.

Keep emergency call.

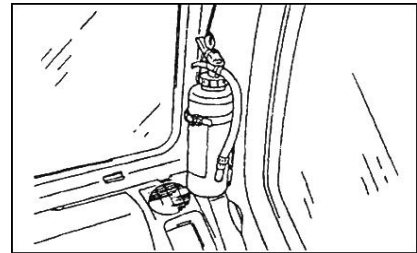

●Confirm the safety of the construction site.

Please check and record the terrain and the geological properties, to avoid dropping or slump of the machine.

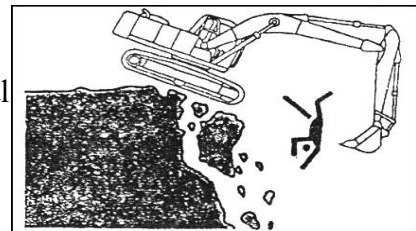

●Inspection before operation.

Check the machine before starting. If any problems, repair it immediately. Keep clean of the front window, working lights and the mirror clean at any time.

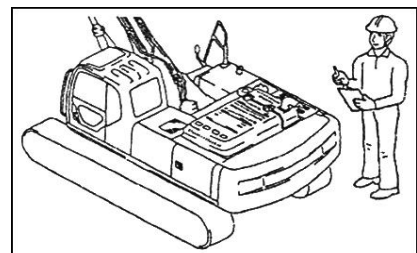

●Please lock the operating rod before leaving.

The color of handle lock rod is red,Please set the safety lock rod at the locked position when you leave the operator's seat. If the operation rod is not at the locked position, and the machine be touched by accident, then the machine moved, and may lead to danger. So, please keep the bucket down the ground and lock the operation rod, turn off the engine and locked all the keys before leaving.

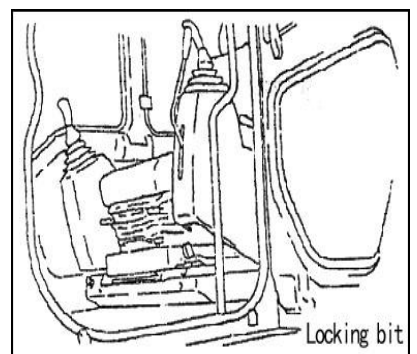

● ***Pay attention to the indicate and the marks***

Put the mark point at the soft earth, if necessary, the driver should pay attention to the marks and comply with the flag director. All the workers should grasp the meaning of all the marks and the signals. And all the marks and signals should be operation by one person.

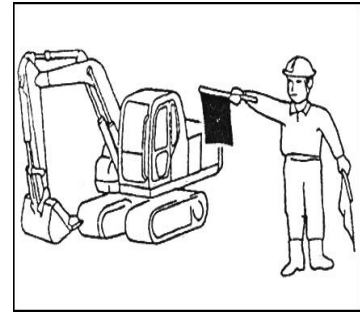

● ***No fireworks at the diesel and engine oil place.***

Engine oil, antifreeze, especially the diesel is flammable material,

So please keep the fireworks far away.

Please turn off the engine when you oiling.

Please screw down lids of diesel oil and engine oil to keep the oil in the storage period.



● ***The considerations near the noise area.***

It may cause deafness when work for a long time in a noisy environment. So, please wear the earflap or earplug if long time working.

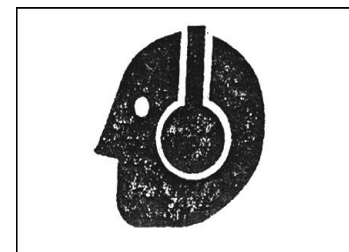

● ***Use handrail and Pedal***

Please use railing and pedal when you get up and down the machine. And check and clean the railings, pedals and the fixing parts. If necessary, please clean the oily material such as the lubricating liquid to avoid the accidents.

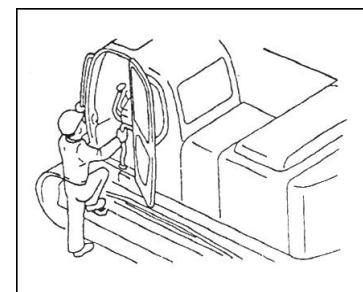

●***Please don't open and check the lids at high temperature.***

The temperature of the cooling water of engine, engine oil and hydraulic oil will become hotter

At that time, please open and check the lid after temperature lower to avoid scald.

●***Select suitable parts.***

Read the book carefully before selecting and assembling parts. And use the recommended or appointed parts by "HT". Or it may cause accidents and shorten useful time and performance."HT" is not responsible for injuries, accidents and machinery breakdown caused by incorrect using parts

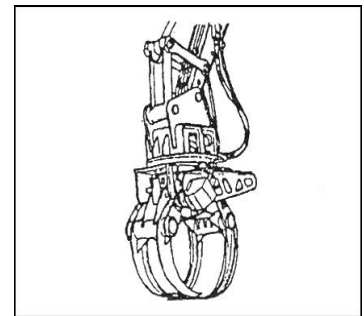

●***Avoid Fire***

Clear all the flammable material, such as wood chips, dull leaves and waste paper etc. Because these materials may cause fire!

Please check diesel, engine oil and hydraulic system leaking or not. Because it is necessary to repair any leaking place and clear all the leaking oil.

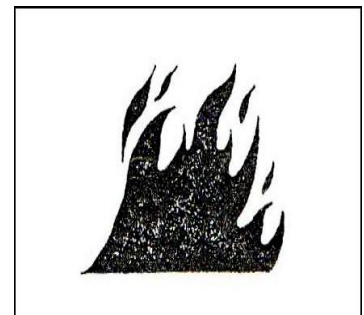

OPERATION NOTES

● ***Starting the engine correctly***

Please press the horn to warn the people around you before starting the engine on the operator seat.

Please don't start the engine by the method of short circuit or battery. Because it may cause serious accidents or the damage of the circuit system.

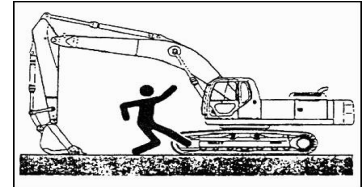

● ***Keep other person far away the machine.***

The operator should prevent other person to climb on the machine, because it may lead to serious injuries.

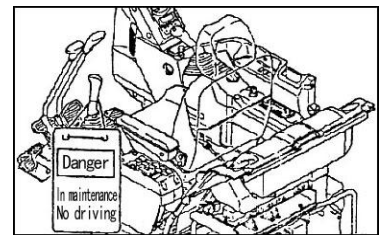

● ***The warning signal before engine starting.***

Please confirm no person in the working area before starting the engine and then press the horn to warn other people. If there is warning hanger on the joystick, please don't start the engine.

● ***Please confirm the directions of the upside of the machine before operating the travel joystick. (Pedal)***

A. Please confirm the position of travel motor before traveling.

B. Please notice that, if the travel motor in the front, please forward the travel joystick, then the machine is

backward

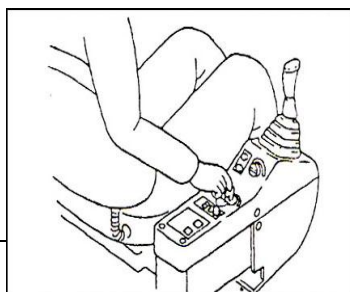
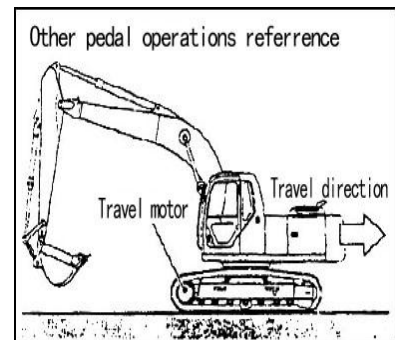

● ***Please comply with the notes of rotation or traveling.***

Please prevent other person touching the rotation area and please confirm there is no other person or hold back in the working area before starting. Therefore, press the horn to warn others! If it is dangerous or bad visibility, please find another person to guide the directions.

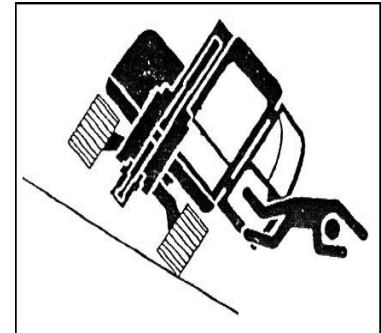

● ***Be careful when you work at the slope.***

Please work slowly and be careful for the overturn or the moving, because it is very dangerous of slope working. In order to keep the bucket down the ground urgently, please keep about 30-40cm between the machine and the ground when traveling on slope. Please don't turn the body direction and landscape orientation traveling. Please detour safely when you back to the flat ground.

● ***The notes when you working on the ground covered with ice and snow.***

Reduce the speed, and don't start, stop and rotate so quickly, because the machine may slide because of the little slope.

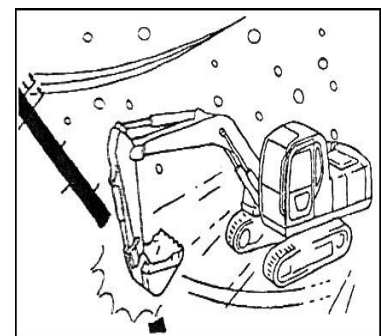

The snow is deeper at the verge of the road and the snowdrift, so the frozen earth will become softer because of the higher temperature.

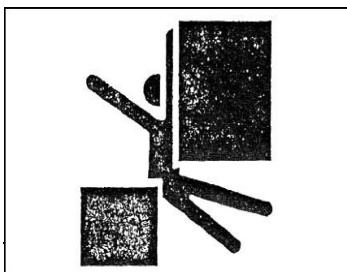

● ***Please comply with the following traveling notes.***

Please keep the position at the right picture. The distance is 30-40cm between the bucket and ground.

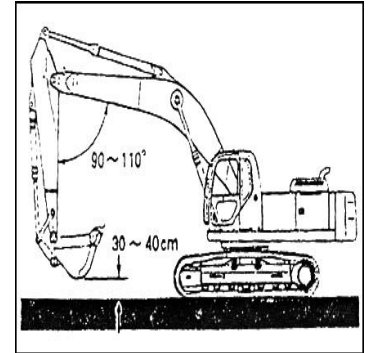

Please don't turn the direction and get over the barriers when moving the machine at lower speed and traveling at bad ground. If have to do, please keep the bucket near from the ground and move slowly.

● ***Notes of the operation in dangerous area***

It maybe unbalance at the shoulder of the road and the edge of the cliff.

In order to draw back quickly at emergency situation, please put the travel motor at rearward.

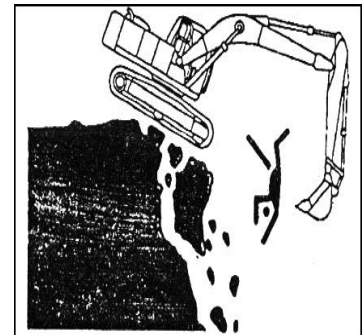

Because the shoulder of the road may collapse, so, please confirm the machine under safety balance ground, and doesn't excavating the earth near the machine.

● ***Load lifting Notes***

Because it is excavator, not crane, so please pay much attention to the load lifting.

WARNING	
Lifting goods by hook only not use bucket teeth	

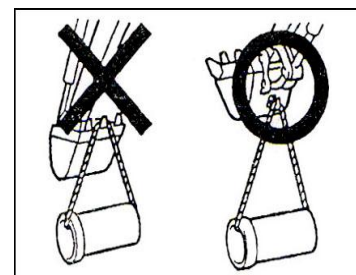

● **Notes at the slope**

Please pay special attention to the operation on slope because of its unbalance. Try your best to travel by up and down way, not landscape orientation.

Please doesn't swing when the bucket is full of material, if have to do that, please make working platform at the working area.

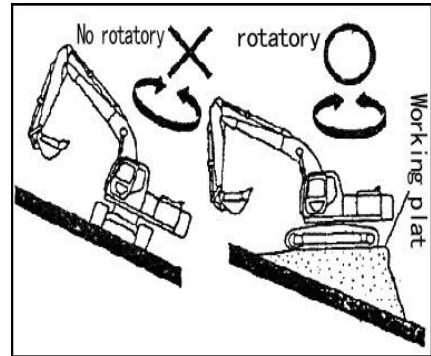

● **Notes of the operation under the electric wire.**

It may cause serious injuries if the machine or the arm touched the wire.

So, please keep enough distance from the machine to the wire when you are working

The minimum distance standard as follows:

Voltage(V)	Target Distance	Standard
Under100.200	Above 2m	
Under 6.600	Above 2m	
Under 22.000	Above 3m	
Under 66.000	Above 4m	
Under154.000	Above 5m	
Under275.000	Above 7m	
Under500.000	Above 11m	

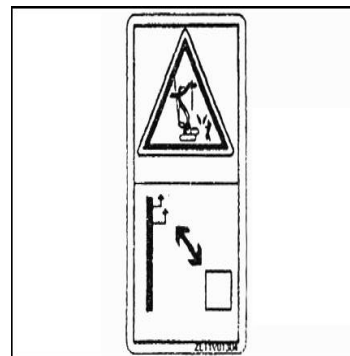

● **Notes--there is pipelines under ground near excavating area.**

Please consult with the relevant departments to confirm the exact position when meet water pipes or gas pipes. Then, excavating carefully.

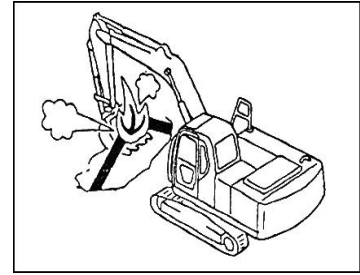

● **Notes of Parking.**

Please park on the flat ground. If you have to park at the slope, please make the bucket down the ground and put obstacle back the track.

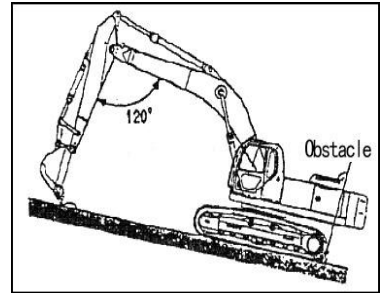

Please avoid holding up the traffic when you park on the road. Or put the warning marks such as flags, lights to warn the people or the vehicle.

● **Please operate the machine carefully at different working places.**

The machine operation is highly limited by different working places such as tunnel, under the bridge or the wire etc. Please avoid touching anything by the working equipment.

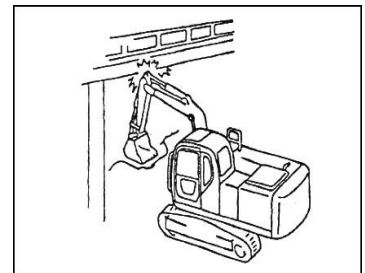

● **Please keep the working equipment steady.**

After unloading the working equipment, please put it down the ground steady to avoid falling.

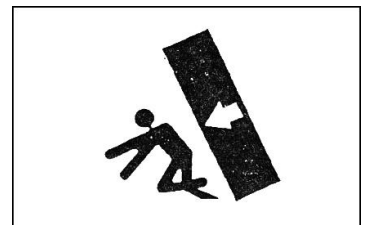

Notes of Checking and maintenance

● *Warning board of checking and maintenance.*

It is dangerous if someone starts the engine or moves the operation joystick when you are checking or repairing the machine, so please hang warning signal--“No operation” at the operation joystick. And put warning signal near the machine if necessary.

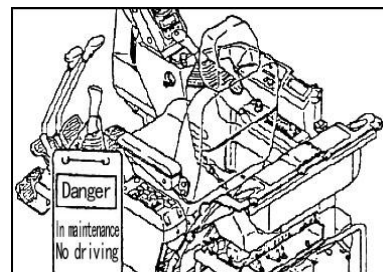

● *Select suitable tools*

Please don't damage or break the tools, or use in other areas. Meanwhile, please select suitable tools when you maintain or repair machine.



● *Keep the machine clean*

It may cause accidents because of engine oil or grease leaking, so please keep the machine clean at any time.

It may cause no operation or unusual because of infiltration water of the electrical system. Prohibit cleaning detector, adapter and the operator's seat by water.

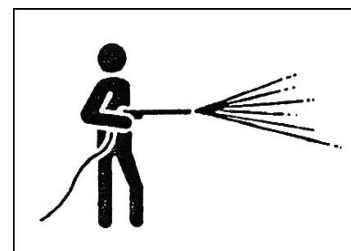

● *Please turn off the engine when checking or repairing.*

Hand or clothes maybe clamped by the running engine, so, please turn off the engine before checking and repairing the machine.

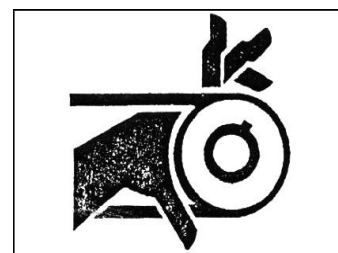

●Notes of filling-engine oil and diesel

Please filling at draughty place. Because, the slippery oil will make the floor wet and slippery and lead to accidents, so please clean the slippery oil. Screw down the lids of the diesel and engine oil after oiling.

Note: don't clean the machine by diesel oil.

●Use bracket when jacking-up the machine.

It may cause accidents, if you jack-up the machine without the bracket.

If you want to check the bottom of the machine, please keep 90degree-100degree between the arm and the boom when jacking-up the machine. Get the bucket down the ground to up the machine, and then use safety bracket jacking-up the machine.

●Be careful of the high pressure oil

At normal condition, there is pressure in every hydraulic oil pipe, so please don't oiling or clean the oil and check or repair the machine before releasing the inner pressure.

It may injure your skin or eyes, even a small-bore leaking of hydraulic oil. Therefore, please wear protective goggle and gloves and check the leaking area by spanner or thick paper.

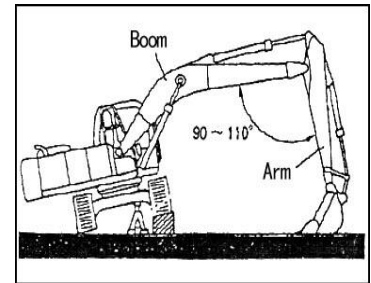

•Notes of repairing at high temperature or pressure

The cooling water of engine and engine oil are at high temperature when the machine just stopped.

At this situation, it may scald you if open the lids or change engine oil, water, or filter element. So, please check and maintain the machine after lower temperature.



•Please pay attention to the hydraulic grease when you

Adjust the tightness of the crawler shoes.

There is high pressure in the grease oil cylinders. The grease may spray if the grease fitting loosen suddenly

Please don't loosen the grease fitting suddenly or turn over a round. And keep face, hands, feet away from the facing place.

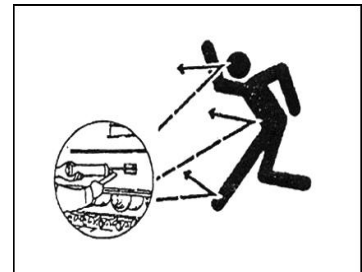

•Use special working lights

Please select explosion-proof lights when you check the diesel oil, engine oil, cooling water or battery. Because it may cause explosion if you use other lights equipments.

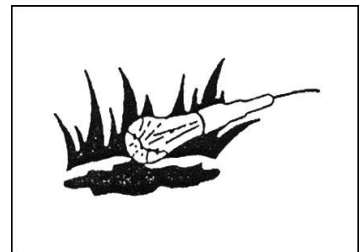

•Notes of electrical system working

Please dismantle the cathode wire of the battery before you repair the electrical system or welding. Or, it may damage the electrical system.

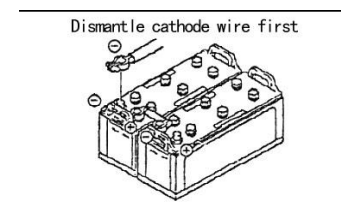

•The suitable steps of abandoning the waste fluid

Please comply with the relevant rules and regulations when you abandon the waste engine oil, diesel oil, cooling water hydraulic oil, solvent, filter element, battery or other toxic substance. Please

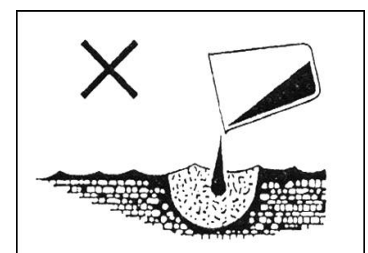

use the container when you drain the waste fluid. Please don't abandon the waste fluid at ground, the river or the lake, because it may cause environment pollution.

Notes of using battery

● *Avoid burn by the battery fluid.*

You should wear clothes with long sleeve, protective goggle and gloves.

If battery fluid touched the clothes, skin or eyes, it may cause burn or blindness. So, please wash your eyes at once and see the doctor.

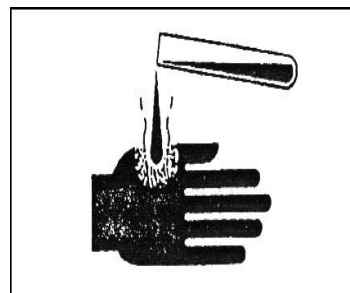

● *Avoid battery explosion*

Battery may produce explosive hydrogen, so please keep the flames away. Screw down the joint terminal of the battery indeed.

Please keep it at ventilated place when you open the lid for charging.



● *Note-When you start the engine by auxiliary line.*

Please wear the protective goggle when you start the engine by auxiliary line.

Please keep determinate distance between the normal machine and not normal machine when you start the engine by other machine.

When connecting, please connect the anode first, when dismantle, cathode first.

Confirm that, there are no tools the anode and the machine. If connected by the tools, it may cause sparkles. It is very dangerous. Nohow, connect the anode of the auxiliary line to the

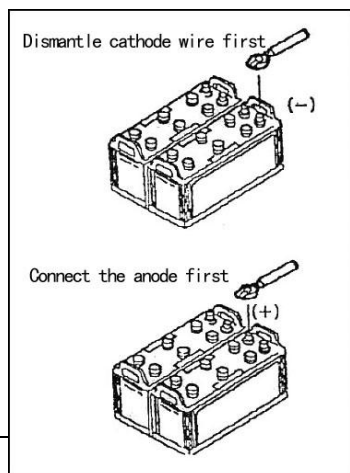

cathode.

THE POSITION OF THE SAFETY MARKS

On this machine, there is safety marks pasted at the special attention places. Please take enough time to grasp the position of the safety marks and dangerous contents of precautions.

• *The usage of safety marks.*

Please confirm the safety mark is clear. If we can't see the words or the picture clearly, please clean the face of the safety mark or change other new marks.

Please clean dirty materials on the surface of the safety mark by cotton fabric or detergent, not organic solvent or gas line.

Please contact the appointed repairing factory or "HT" company for changeable new marks when it becomes damaged, lost or unclear.

• *The paste position of safety mark*

△ Prohibit entering the rotatory range—Paste at both sides of the balance weight.

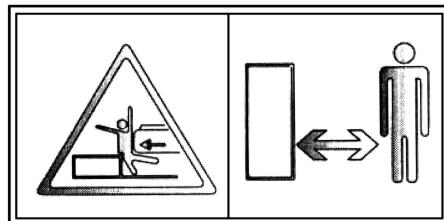

△ Notes of Checkup, repairing engine—Paste it at the engine water tank

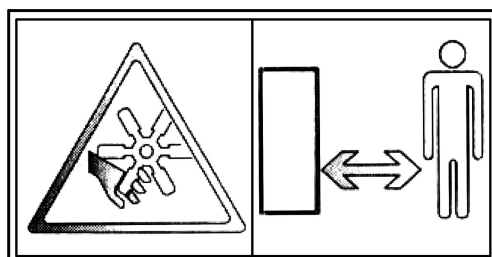

△ No fireworks—Paste it outside of the fuel tank, hydraulic oil tank.



△ Urgent escape route—Paste it at the back of the cab

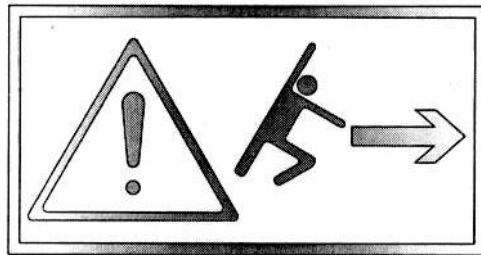

△ Notes of high temperature—Paste it at the engine water tank and the high temperature part.

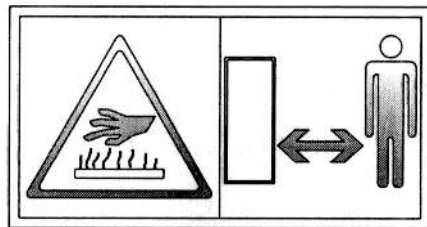

△ Notes of the action of the working equipment—Paste it both sides of the dipper.

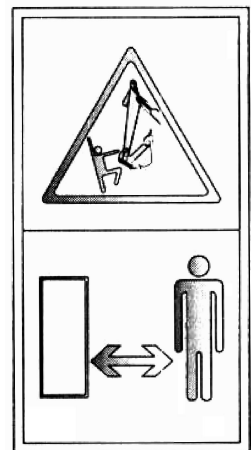

Chapter 5 Transportation and parking

TRANSPORTATION ON ROAD

Before transport the machines, please remember main specifications and dimension,

And check overall weight, length, width, height, travel speed and the ground pressure etc.

Please check the road width, bridges and road situation, the traffic situation before transportation.

If related to regulations of the road traffic, machinery or tools transportation, please obtain prior approval from the relevant authorities.

●Up and down the flatbed

Warning!



Please be slowly up and down and the flatbed!

Don't use working equipment from top to bottom of the flatbed, otherwise it might cause accidents.

Don't use other joysticks except the travel rod on the slope.

Pay special attention to the barycenter of the machine up and down the slope in order to avoid sudden change of focus.

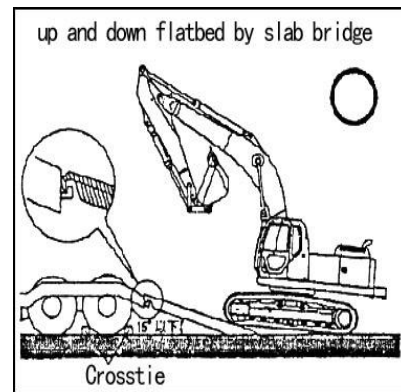

1. The machine should be up and down the flatbed on the flat ground.
2. Use the sufficient length, width, intensity and inclination to connect ramps. Please choose the non-slip-like ramps in rainy day.

3. Please check if the machine and the bridge deck are in the same line before up to the deck.

Basically speaking, the travel motor is back when up to the flatbed, front when down to the flatbed.

4. Please let the front first if with the working equipment and the back first if without the working equipments. Only for balance.

5. Parking at the fixed position when up to the flatbed machine.

6. After got on to the plat bed, please do the following operations.

- 1) Keep the excavator balance at the rear wheel of the flatbed to avoid the machine moving.
- 2) Turn the upside of the machine to 180degree position.
- 3) After getting to the proper place, please down the front working equipment slowly.

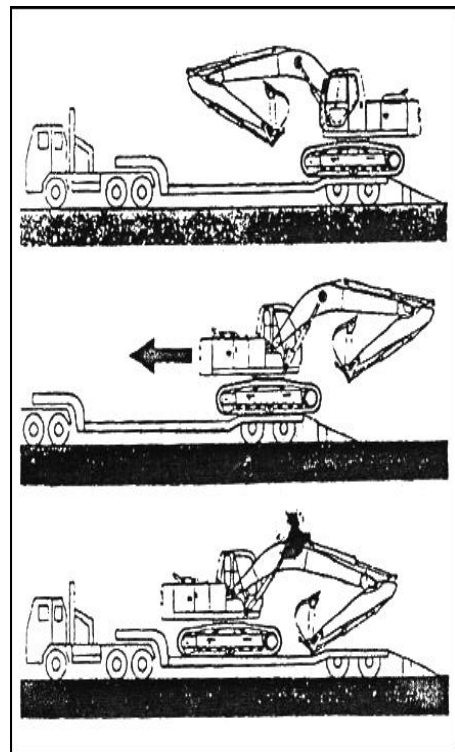

• Fixing Machine

Please check the following steps to fix machine, when the excavator pa

1. Pulling the security lock bar to lock position.
2. Turn off all the switches, remove the start up key.
3. Lock all the lids and doors.
4. Select sufficient steel lock to fix the front and rear of track. In order to prevent moving of the machine. All the parts should be fixed on the flatbed indeed.

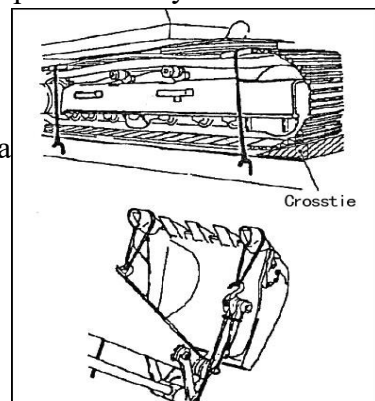

• Excavator Parking

<p>Attention </p>
<p>Please close the door and the window when you parking, or the wind and rain may damage the electrical parts, such as controller etc.</p>

1. The machine should be parked on flat ground. Then keep the

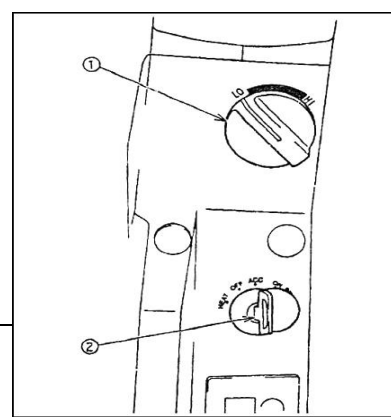

arm vertical and digging bucket down to the ground.

2. Pull up the security lock bar, and set it at the locked position.
3. Set the bar at low throttle position, and running five minutes. Then, making the temperature lower and lower gradually to extend engine life.
4. Rotate the switch to the OFF position to close the engine, and then pull out the key.
5. Please close the window, door, and each guard and then lock the machine before leaving.

● ***Excavator Parking at the slope***

Attention



It is very dangerous parking at the slope. So, "No parking at the slope, please".

If you have to park at the slope, please make the bucket down the ground. Please put obstacle back the track after all the joysticks at original position.

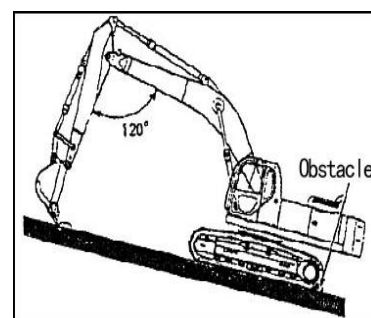

Chapter 6 Notes of Operation and Control

Unallowed Operation method

- *Don't operate the machine by rotatory force.*

It may damage the arm and reduce the use life of the swing system if you move the stones and oddments or pulling down the wall by mechanical swing force.

- *Don't do dragging actions*

Don't drag the bucket by travelling way. Because, this way may damage the the structure of the machine .

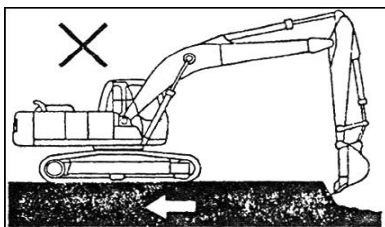
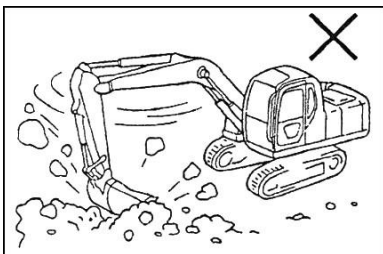

Move the hydraulic cylinder to the terminal point carefully.

If bucket cylinder and arm hydraulic cylinder been moved the terminal point repeat time and time. It may damage the hydraulic cylinder because of over wearing when you shake the bucket full of soil. So, please stop move the hydraulic cylinder while going to the terminal point.

Avoid striking actions

It may damage the structure of machine if you do striking actions by bucket.

Prohibited wrong operation

The counterweight of machine off the ground is prohibited, otherwise, damaged the structure of machine

●Lifting the goods

The machine is designed for excavating and loading, therefore, please be careful, when it is used as a hanger. Don't overweight the machine; use the authorized hang chain but the bucket lips.

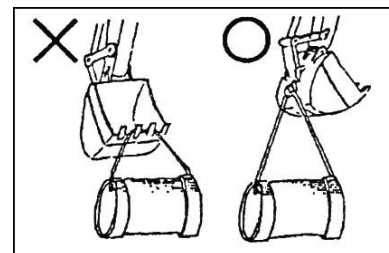

Be careful when deep excavating

Don't let middle part of the boom and bucket hydraulic soft pipes hit the ground or crawler

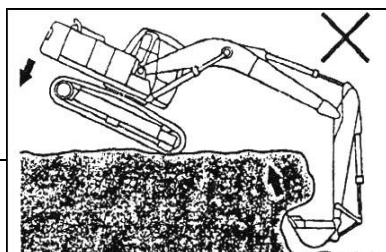
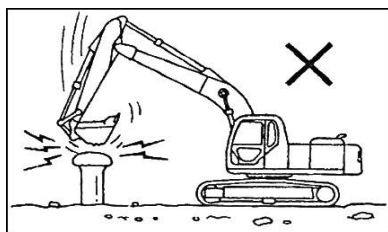

Prohibited working equipment knock machine body

The bucket may hit the cab or the front part of the machine

when you operating the arm, boom and bucket at the same time.

Confirm if it will affect other parts when you use the new boom

at the first time.

NOTES FOR OPERATING BREAKER

● ***Prohibit hitting the object fiercely.***

Because the hydraulic breaker is heavy than the bucket, and the falling speed is quicker, so, please pay special attention.

It may damage the front part of the machine and the swing part.

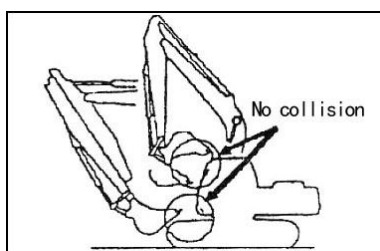
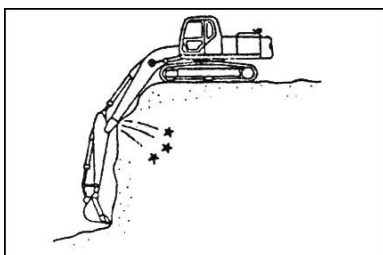

The rock breaker can be only used in shredding

Please don't use at other areas except shredding. Please set the machine at flat and steady ground when you operate the rock breaker.

When the breaker working,

unallowed full extend the piston rod of hydraulic cylinder.

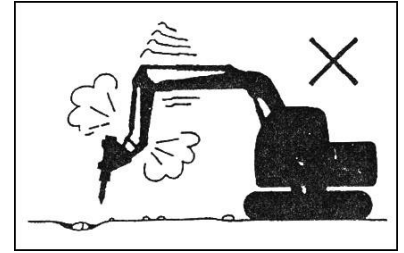

● ***Please don't hit the objects by falling rock breaker.***

Prohibit breaking the objects by the self weight of the breaker up and down. Or it may because arm parted

● ***Don't move the objects by the side or the back of the breaker.***

Don't move the objects by the side or the back of the breaker.

Because it may damage the hydraulic breaker.

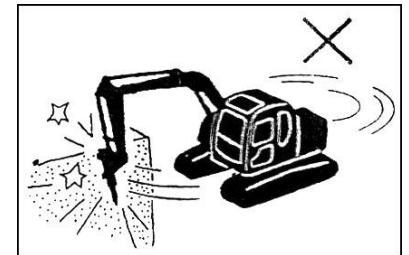

● ***Avoid continuation hitting over 1 minute***

If the earth or the stone have not been broker after one minute hitting, please change another type impacting head. It may cause the oil temperature rising, pressure reservoir broken and the hydraulic cylinder oil seal damaged.

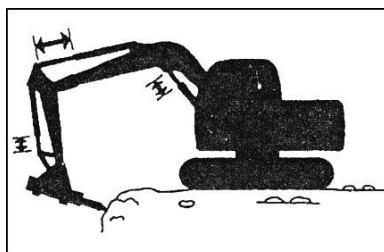
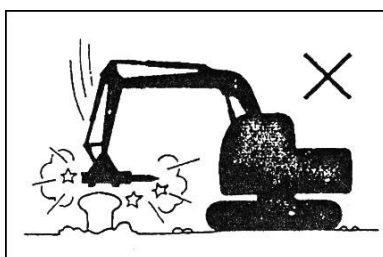
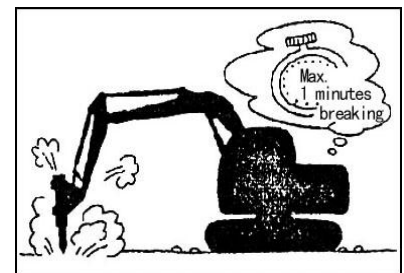

Please stop working if the hydraulic oil pipe shaking.

If the hydraulic soft pipe shaking unusual, it means, there is something wrong with the pressure reservoir, so, please stop operation and contact the manufacturer

Please don't lifting the objects by the breaker.

Please comply with the “Safety First” rules. Don’t hang the objects by the breaker.

● ***No working in the water***

The hydraulic breaker rust may damage the sealing elements, because hydraulic oil with mixed of the rust, other material or water may lead to hydraulic system damaged.

● ***Prohibitory operations method for breaker.***

If you use the up swing body to operate the breaker,

it may bend the crawler because of over load. So,

you must operate the upon structure by the correct ways.

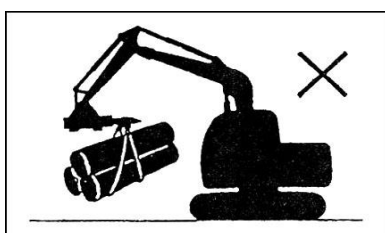
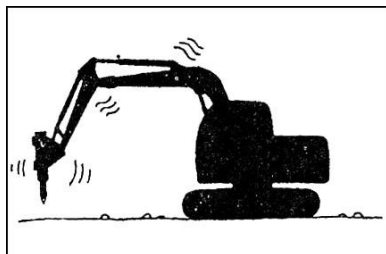
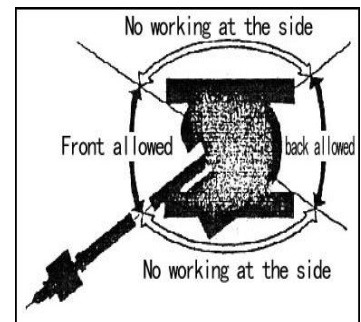
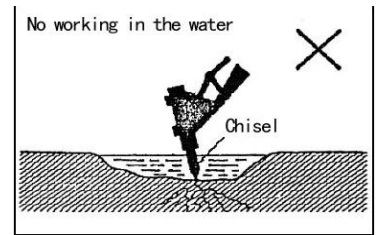

● **Care the impact between the breaker and the boom.**

Please operate the arm, bucket joysticks carefully, in order to prevent the impact between breaker and boom.



● **Notes of working with the whole machine floated.**

Please be appropriate when you work with the whole machine floated, or it may damage the working equipment.

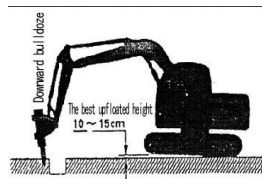

● **Notes trench excavating**

Please keep the same machine direction and the excavating direction when you digging the trench. And excavating and drawing back at the same time.

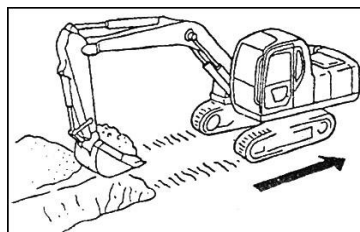

● **Loading**

A. Please move the machine to the back of the truck when loading, in order to avoid touching the operator's seat or other persons by revolving the arm.

B. It is easier and quicker you loading back of the truck than loading at side

● **Revolving**

When you release the operation joystick to the neuter place, there will be light rotation because of suddenly stop. It means please consider the reasonable distance before stopping rotation.

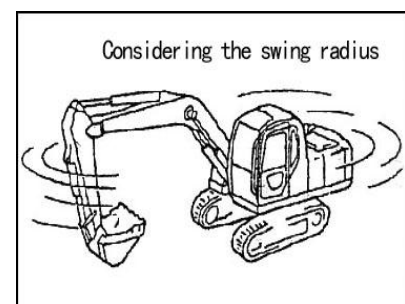



Attention

Please use the slow speed swing switch when working at narrow place. With this method, you can reduce the swing speed and keep the operation more safety.

Notes after operation

1. Please lower the bucket on the flat and hard ground without stones or stratum slips after operation.
2. Please oiling full but not up to the top of the oil tank. If you oiling to the top of the tank, and the outside temperature is rising, then the diesel oil may expand and overflow.
3. Clean the soil attached on the crawler assembly.
4. Check all the engine oil or cooling water is leaking or not. Meanwhile, check the arm, outside and the crawler assembly, if any damaged, please repair it at sight.

Chapter 7: The structure characters

★Engine

excavators usually choose the 久保田, turbo supercharged engine .Low fuel consumption, low noise, and the discharge have reached the Europe Standard I.

★★Hydraulic system

The hydraulic system chooses the whole function variable pump, so, the excavators are of high quality and good reliability. And the integral multitandem valve system can achieve dual pumps interflow, and also complex actions. In addition, we choose pike sealing elements, and brand hydraulic cylinder.

★★★Structure.

We choose Komatsu technology for the excavator body structure, arm and boom. With standard whole rigidity chassis, strong “X” type frame, elasticity buffer expansion equipment, resistant to impacting, good stability, use reliability.

Chapter 8: Daily Maintenance & Servicing

★*Recommended Maintenance Part*

1. Cooling system

Please don't add cooling fluid to the hot engine. Let the engine cool off at first. Please check the cooling fluid rate regularly in cold winter in order to confirm enough protection.

If the temperature of the store or working place is frozen temperature, the cooling system should be protected according the expected lowest temperature.

All the water is not causticity at the engine working temperature.

The cooling system should be protected by the cooling system anti-rust; the viscosity is 3%-6%, whatever the anti-rust viscosity is.

Over rich cooling fluid anti-rust (over 6% recommended) and the antifreeze (65%) mixed may cause pulpy settlings, and then it may lead to radiator pipe blockage and overheating.

If the cooling system is dirty or engine overheating, or foam in the radiator, please clean the cooling system.

Please mix the cooling fluid in advance, in order to supply the protection for the cooling system at expected lowest outdoor temperature. The frozen temperature of undiluted, pure anti-rust is -23°C.

Please unload the radiator cap when discharge the cooling fluid and clean it completely. Please don't stop the engine working until the cooling fluid level becoming stable when you oiling the cooling fluid.

2. Fuel system.

Please fueling to the fuel tank at the end of the working everyday to repel the moisture in order to avoid solidifying. And, please don't fueling so full, because the it may cause overflowing because higher fuel temperature.

Warning



Please doesn't fueling to the packed bed filter unless you have assembled the packed bed filter? Because you make the fuel dirty, it may cause accelerated wear of the fuel system parts.

3. Hydraulic system

Please mix it very well of the new additional lubricant and the old lubricant in the system.

Please choose oil products only except other products are acceptable for the system equipment.

If the water and air going in to the system, the hydraulic oil will become feculent. And the water and the air in the system will cause hydraulic pump damaged. So, please drain the hydraulic oil, re-tighten all the clips of the hydraulic system. And at last, clean and refuel the hydraulic oil

4. Inlet system

If air filter element is dirty, it not only reduce the engine output power, but also increase the fuel consumption, and also cause harmful gas discharging and black gas. Now, please clean or change thick filter element.

Please clean four times before changing the thick filter element. Please check all the filter element material tearing or not when cleaning. Please change once for a year even we don't clean the filter element four times.

WARNING



Please change thin filter element when you maintenance the thick filter element at third time. Please doesn't use the thin filter element again after you clean it once, please change other new spare parts?

If there is still black smoke from the engine after you assembling the clean filter element, please change for the thin filter element.

★★Maintenance items at any time

1. Bucket teeth and edge shovel cutter

DENGAROUS



The fixed pin may fly out when it is knocked, and also, it may cause injuries of the around people. So, please confirm that, there is no person around when you knock the fixed pin. In order to avoid hurting your eyes, please wear the safety spectacles. And you should pad the bucket very well before changing the bucket teeth and edge shovel cutter.

2. Crawler shoes

A. Please set a straight rod which is over the length from the chain wheel to the directive wheel on the crawler

B. Check the maximum extent from the top of the crawler to the bottom of the straight rod. The best adjustable moderation should be about 40-50mm.

C. Please adjust the tightness of the nuts until the crawler achieved the suitable extent.

3. The maintenance of the swing bearing

Please fill up the grease on time, pay attention to the wear station in the working and change the damaged steel ball in time.

4. Filter

	ATTENTION
In order to prevent the damaging of the engine, only allow to maintain the air filter When the engine stopped.	

A. Check the filter element

Through check carefully, if find the filter element has hole and please replace it in time

B. Replace the thick filter element.

Loosen the aerofoil nut, and disassemble the thick filter from the air filter body. Clean the bottom of the air filter body. Clean and check the thick filter element, and reassemble the clean thick filter element. Screw down the aerofoil nut reliably. Don't screw down the aerofoil nut by tools.

C. Replace the thin filter element

Attention: The thin filter element must be changed, and don't use it again after cleaning.

Please change the thick filter element to thin ones after maintenance for three times. If there is still black smoke of the exhaust after assembling the clean thick filter element, please it for thin ones.

Disassemble the aerofoil nut and the thick element filter.

Loosen the aerofoil nut; disassemble the thin filter element from the air filter body. And close the admitting port of the engine. Clean the inner of air filter body, and lift down the lid of the admitting port.

When you assemble the thin filter element, please screw down the aerofoil nut reliably.

Reassemble the thick filter element, and screw down the nuts reliably.

D .Clean the thick filter element

When you clean the filter element by pressure water, please set the highest pressure at 0.28Mpa to avoid the filter element damaged; Please don't use tulle cirnoline,sealing ring or gland bush damaged filter elements; don't clean the filter element by hitting or knocking.

ATTENTION 
The pressure air is harmful to your health, so please wear face guard and protective clothes and protective shoes when you clean the filter element by pressure air.

★★★Daily maintenance:

1. The periodic chart of Lubrication and maintenance

Maintenance items at any time	The maintenance content
Bucket teeth and edge shovel cutter	Check wearing or injures update
Crawler shoes	Adjustment when the crawler can't keep vertical.
Bucket clearance	Check-update
Air filter	Check-update
accumulator battery	Check-update
Maintenance items every 10 hours or daily.	
The whole machine	Checking the machine
Engine crankcase	Check the engine oil section
Engine cooling system	Check the cooling fluid section
Hydraulic system	Check the oil section and leaking or not
Indicator and instrument	Lubrication and cleanliness
Travel system	Check the lubricant leaking or not, wearing and bolt loosen

	and unusual noise
Maintenance items every 50 hours or every week.	
The joint rod part of backhoe bucket	Lubrication and cleanliness
Maintenance items every 100 hours	
Engine fixed bolt	Re-screw down the fixed bolt
Hydraulic system	Replace or clean trap valve
Swing gear	Check the grease lubricant and dirty situation
Maintenance items every 250 hours or every month	
Crankcase respirator	Clean the respirator
Engine crankcase	Replace engine oil and packed bed filter
Initial valve clearance, fuel feeding timing	Adjust at the first replacing oil, normal maintenance, the period is 2000 working hours or a year
Fuel packed bed filter	Replace the fuel packed bed filter
Fuel feeding trap valve	Clean the trap valve
Soft tube	check
Water pump and fan leather belt	Check and adjust
Cooling system	Add anti-rust
radiator fan	clean
Terminal transmission	check
Swing transmission	check
Swing bearing	Check unusual noise and loose
Hydraulic oil purulator	Clean purulator
Maintenance items every 250 hours or every three months	
Air packed bed filter	Clean the filter element by pressure air or pressure water
Engine fixed bolt	Re-screw down the fixed bolt
radiator fin	clean
Fuel tank lid and trap valve	Clean lid and trap valve
Hydraulic system	Clean oil absorption trap valve
Hydraulic oil purulator	Clean purulator
Maintenance items every 1000 hours or every 6 months	
Air packed bed filter	Replace filter element
Swing transmission	oil change
Maintenance items every 2000 hours or every 12 months	
Cooling system	Change cooling fluid
valve clearance, fuel feeding timing	Adjust the valve clearance
Maintenance items every 4000 hours or every 2years	
Hydraulic system lubricant	Oil change

2. Maintenance items every 10 working hours or daily

A. Engine oil

Please don't filled too full in the engine crankcase to avoid the engine damaged; please check the engine oil level when the machine is on the flat ground before starting the engine. Please check the engine oil level after working; it is about 30 minutes after the engine cut off. Whatever the replace period, please change the dirty or alterative engine oil as soon as possible.

B.Engine cooling system

Disassemble the cover of fluid filling port slowly to release the pressure, and observe the

cooling fluid level.

C. Hydraulic system

ATTENTION 
Please pay attention to the following items when you check the oil level: hydraulic tank is hot at the working temperature. Hot oil will cause to scald. So, if the oil is hot, please don't disassemble the oil tank lid from the hydraulic oil tank. It will damage the oil pump if the air going into the system.

Check the hydraulic system has oil leakage or not.

D. Travel System

Check if there is wear or loosen bolts on the carrier roller, track roller, idler, crawler shoes, and drive sprocket.

Listen if there is unusual noise when the machine traveling on the wide ground slowly.

Warning 
Please check and maintenance when you find unusual wear noise.

3. Maintenance items every 50 hours or every week

Inject the grease lubricant to the lubricant oil.

4. Maintenance items every 100hours

A. Check the engine fixed bolt is tight or not, if loose, please rescrew it down.

B. Check the rubber cushion pad is deteriorating after injures or not.

C. V- belt: The water pumps, fan of the engine are driven by the V- belt. In order to develop the specifications of the engine and improve the efficiency, please check if wear or burst or not. To make the belt slipping at minimum, please check and adjust the tightness of the belt. Slipping will reduce the use life of the belt; it also will damage the water pumps or other equipment.

Warning 
In order check the tightness of the V-belt, please set 10kg force at the middle of the two belt pulley.

5. Maintenance items every 250 hours or every month

A. engine crankcase, Replace engine oil and packed bed filter

B. Soft tube, it is most economic and reasonable to replace the soft tube before damaged.

This is a preventive maintenance method. By this way, we can reduce the loss of working time. Check all the soft tubes if burst or not. Please replace the burst soft tube and loosen soft tube to tight the loose pipe clamp.

C. Cleaning the fuel tank: Please drain the water and cleaning the dust at bottom of fuel tank

D. Replace the air filter element

6. Maintenance items every 500 hours or three months

A. Clean the surface of the radiator.

Dangerous	
Please wear protective goggles when you clean the cooling system. Because pressure water making flying splinters may injure you body.	

It is allowed to clean the radiator only after the engine stopped. Otherwise, the turning fan blade will cause injures.

You can clean the dust, leaves and other splinters by pressure air, pressure water or high pressure steam. You can choose the right clean method according to different situations, but the prior method is pressure air.

Plases clean the radiator carefully, otherwise, it will damaged the radiator and cause water leaking.

B. Fuel system of engine

Please check the injection oil pressure of injection oil pump, same time, replace the fuel filter element.

Please cleaning the around of filter before replace the filter element, when cleaning, don't let any dirty go into the scree of filter,. Clean the scree of filter by nonflammable fluid and install the

part after dry.

C. Hydraulic system

Replace the return oil filter element and suction oil filter element, same time , check the system pressure.

D. Check the support of engine

Please check the cushioning pad and connection bolt carefully .

E. Slewing bearing

Swing the up structure 360degreee after stop the engine, and check the gear section of the swing system, then fill the grease lubricant.

If the density of the grease lubricant is too big, the stir losing may become larger. And the swing grease lubricant will go to bad. It will cause the swing driven small gears and the swing gears damaged because of bad grease lubricant.

F. Check the battery

If found the battery damaged and replace it , if found the battery has lower power and charging in time.

G. Check the tightening torque for drive sprocket and track roller

Please check the tightening torque of drive sprocket and track roller, if found the bolts loose and repair it in time.

7. Maintenance items every 1000 hours or six months

A. Replace the grease lubricant of the swing system. Check the oil level of the idler and track roller and carrier roller.

B. Adjustment the valve clearance

Because the valve and the valve actuating mechanism parts initial wear and breaking, we should check the valve, fuel at about 250 hours timing for the new or repaired

engine. After that, we should check and adjust these parts every 2000 hours.

When you check the valve clearance, no need adjust the clearance checked if in the stated range $\pm 0.08\text{mm}$.

Please correct to adjustment the valve clearance , otherwise , the wrong adjustment will reduce the use life of engine .

ATTENTION 
Please doesn't start the motor to driving the flywheel, Please let the engine cooling for a period before checking the valve clearance.

8. Maintenance items every 2000 hours or 12 months

A. Please replace the hydraulic oil and cleaning the suction oil filter element of pump. Please replace the hydraulic periodic, which will increase the using life of hydraulic parts and machine reliability.

ATTENTION 
Please don't operate any joysticks before the air of the hydraulic system release completely. Or it will cause the hydraulic transmission breakdown.

B. Change the cooling fluid

Please drain and change the cooling fluid every 2000 working hours or a year.

If cooling fluid is dirty or of foams, please drain the cooling fluid as soon as possible.

9. Maintenance items every 4000 hours or 2 years.

Replace the hydraulic oil of the hydraulic system.

10. Please let the bucket down the ground when parking the excavator in order to reduce the pressure of the hydraulic system, to increase the use life of hydraulic parts.

11. Maintenance items of travel reducer and swing reducer.

A. Preparation before driving

Please fill in the hydraulic oil before the first driving, and the hydraulic oil should

meet the clean requirements. the capacity of hydraulic oil is: travel reducer 1.8kg, swing reducer 3.5kg. Don't add excessive oil. And please check it again after operating for a while.

B. Maintenance

Check oil leaking or not everyday

Check the oil level every week.

Check the joint situation of the outside bolts every month.

C. oil change

The first oil change is after 150 working hours. After that, change the oil every 1500 hours or 6 months at the latest. Please clean the hydraulic oil tank before filling new oil.

Chapter 9: Common faults and trouble shooting

Faults characters	Reason analysis	trouble shooting methods
Can not start the engine or start difficulty	Starter fault	Replace or repair
	Low power for battery	Charged or replace new battery
	Preheat circuit fault	Repair or replace pre-heater
	Fuel system has air or water	Exhaust or drain
	Fuel pipeline blocking up	Cleaning oil-way
	Injection oil pump fault	Repair (contact manufacturer of engine)
	Intake and exhaust block up	Cleaning intake and exhaust system
Power reducing	Output power not enough	Check and repair
	Intake system block up	Cleaning filter element
	Cylinder liner blowing air	Replace cylinder liner
	Oil pump wearing	Check and replace
	Incorrect adjustment of the distributing valve or main overflow valve	Adjust the pressure to the correct extension
	Working oil capacity no enough	Check from the oil system leaking and parts wearing
	oil suction tube intake	Exhaust from the system, tighten the joints checking or change the sealing parts.
Working slowly	Oil pump fault	Check and replace

,powerless	Safety valve fault	Cleaning safety valve or replace
	Oil pump supply oil capacity no enough	Check the oil quality and oil pump wearing, and sealing parts etc, replace them if necessary.
Swing pressure no enough	Adjust pressure of the cushion valve is reducing	Adjust the pressure to the correct extension
	Hydraulic motor leakage	Check and replace
	Swing bearing damaged	Replace
Brake of slewing not working	Adjust pressure of the cushion valve is reducing	Adjust the pressure to the correct extension
	One-way valve block up	Cleaning
Abnormal noise for swing	Big and small gear grease lubricant no enough	Filling grease
	Hydraulic motor performance down	Check and replace
	Overflow valve adjust pressure is too low	Adjust the pressure to the correct extension
	Filling oil capacity no enough	Increase the filling oil capacity
Travel force no enough	Central swing joints sealing damaged	Replace
	Travel motor internal leakage	Replace
Travel unsmooth	There are stones in the crawler.	Remove the sundries as adjustment
	Crawler excessive tension	Adjust it to the correct extension
	cushion valve adjust pressure unsuitable	Adjust pressure to the correct extension
	Hydraulic motor performance decreasing	Check and replace
Travel Off Tracking	Different tension of the track at left and right	Adjust
	Oil pump performance decreasing	Check or replace
	Hydraulic motor performance decreasing	Check or replace
	Central swing joints sealing damaged	Replace
	Changed shape of frame	Maintenance frame
Hydraulic system over- hot	Hydraulic pressure too high	Adjust the pressure valve pressure to suitable
	Unloading valve pressure too high	Adjust to suitable pressure
	Using wrong for hydraulic oil	Replace hydraulic oil
	Oil dirty or oil supplying few	Clean or change the filter, check the oil viscosity. Fill the level of oil of the accumulator to suitable site.
	Oil cooling system fault	Check or replace
	Efficiency of oil pump is too low	Check or replace
	Oil pump suction air	Replace the oil filter, clean the air-logged inlet lines

		and the blow vent of the accumulator, adjust the pump speed.
	Air mixed in the oil	Screw down the easy leaking joints; fill the oil section of the accumulator suitable fully. Drain the air from the system and change the sealing elements of the pump oil.
	Oil pump over load working	Adjust the working load; make the pump accordance with the system.
	Parts wearing or damaged	Check or replace
Distributor oil leaking	Over load work frequently	Operate according with manual
	Hydraulic oil temperature too high	Reduce the temperature
	too much hydraulic oil impurity	Filtered or replace hydraulic oil
	Seal element burn-in	Replace
	The limited cover changed shape, because Distributor mechanism rod over level usually	Adjust and repair
Hydraulic cylinder oil leaking	Hydraulic cylinder travel stop usually, it may cause the sealing element wearing.	Control the stroke of cylinder
	Hydraulic oil temperature too high	Repair or replace cooling system
	Sealing element normal wearing ,burn- in	Replace
Swing reducer has noise or can not working	The bearing of reducer damaged	Check and repair
	Reducer gear wearing	
	Reducer gear damaged	
	Gear-shaped pin loose or fall off	
Oil pipe leaking	Hydraulic system pressure too high	Adjust the pressure
	Oil pipe damaged or burn-in	Replace the oil pipes
	Over load working frequent	Operate according with manual
	O-ring damaged or burn-in	Replace
Hydraulic oil emulsionize or deep color	Water in Hydraulic oil	Replace hydraulic oil
	acid value, Excessive impurity	Heating and filtering or replace
	Hydraulic oil use too long time.	Replace hydraulic oil
Hydraulic oil temperature too high	Hydraulic oil unsuitable selection, viscosity too high and or too low.	Select the recommended hydraulic oil
	Over load working frequent	Correct operation
	Gear pump parts wearing, inner leaking	Readjust, reassemble
Hydraulic system can not	Inner piston of pressure valve for distributor mechanism wearing or	Replace piston cleaning

working	locked	
	Pilot system fault	Check the pressure flow of pilot system
	Gear pump damaged	Replace gear pump
Hydraulic system displacement no enough	Hydraulic oil level too low	Filling hydraulic oil
	Trap valve blocked, breath resistance too much	Replace filter
	Gear pump wearing	Repair
	Oil temperature too high	Reduce oil temperature
	Some joints of the oil suction tube turning cause air breathing and lead to the gear pump wearing	Tighten joints, prevent leaking.
	Filter or hydraulic system no smooth	Replace the filter timing, clean the dirty, and keep the oil cleanness.
Swing reducer oil leaking	The oil sealing of reducer wearing	Replace the oil sealing

Appendix: Drawing of oil filling and draining for reducer

Attention 
<p>After the new machine working for 40 hours (one week), please drain all the lubricant of the swing speed reducer and the travel speed reducer, and then, fill 1/2 diesel oil of the total capacity in the swing speed reducer and travel speed reducer, operate back and front with no load, and drain the diesel oil after full cleanness. Change and fill the new lubricant according to needs.</p> <p>After that, change it once every 150 hours (one month)</p>

Drawing 1. Oil filling and draining of travel reducer

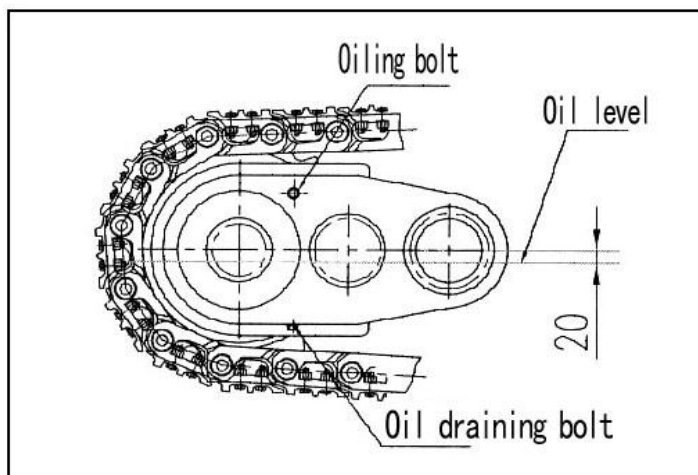

Drawing 2 : Oil filling and draining of travel reducer

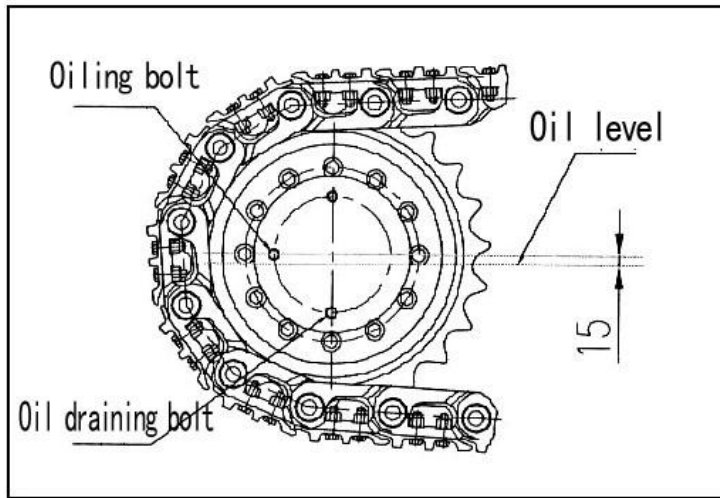

Drawing 3: Oil filling and draining of swing reducer

